

INTEGRA



MEDIAClave Operating instructions



Declaration of conformity

INTEGRA Biosciences AG – 7205 Zizers, Switzerland

declares on its own responsibility that the devices

Description	Models
MEDIACLAVE 10	136 000, 136 005, 136 010, 136 015, 136 020, 136 025
MEDIACLAVE 30	136 050, 136 055

comply with:

EU Directives	Scope	Date effective
2014/35/EU	Low voltage directive (LVD)	20.04.2016
2014/30/EU	Electromagnetic compatibility (EMC)	20.04.2016
2012/19/EU	Waste electrical and electronic equipment (WEEE)	14.02.2014
2011/65/EU	Restriction of hazardous substances (RoHS)	03.01.2013
2014/68/EU	Pressure equipment directive (PED)	19.06.2016

Description of pressure vessels

Operational fluid	liquids/gases	Allowable temperature TS	0-126 °C
Fluid group	2	Test pressure PT	2.5 bar
Max operating pressure	1.4 bar	Pressure test medium	water
Safety valve set pressure, Max allowable pressure PS	1.7 bar	Marking	CE1253
		Safety equipment	assembly

MEDIACLAVE 10:

Serial No.	0267-7999
Category (2014/68/EU)	I (Art. 13)
Chamber volume V	16.3 l
Drawing No./Rev	136400/09

MEDIACLAVE 30:

Serial No.	8000-18000
Category (2014/68/EU)	II (Art. 13)
Chamber volume V	43.2 l
Drawing No./Rev	136450/09

Description of assembly

Pressure vessel, circulation pump, safety valve, circulation heater, heat exchanger, piping

Conformity assessment procedure

Module: A2 (2014/68/EU)

Certificate No.

PED-Z-COS.EP.5507079

Notified body for inspection

Swiss Safety Center AG, CH-8304 Wallisellen, CE1253

Certified Q-System ISO 9001:2015

SQS, CH-3052 Zollikofen, Reg. No. 15072

EU Regulations	Scope	Date effective
1907/2006	Registration, evaluation, authorisation and restriction of chemicals (REACH)	01.06.2007

EU Standards	Scope
EN 9001:2015	Quality management
EN 61010-1:2020	Safety general laboratory equipment
EN 61326-1:2013	Electromagnetic compatibility laboratory equipment
EN 61010-2-010:2017	Safety heating devices
EN 9606-1:2018	Qualification test of welders - Fusion welding - Part 1: Steels
EN 15614-1:2017	Specification and qualification of welding procedures

GBR Regulations	Scope	Date effective
S.I. 2016/1101	Electrical equipment safety	08.12.2016
S.I. 2016/1091	Electromagnetic compatibility (EMC)	08.12.2016
S.I. 2016/1105	Pressure equipment safety	08.12.2016
S.I. 2013/3113	Waste electrical and electronic equipment (WEEE)	01.01.2019
S.I. 2012/3032	Restriction of hazardous substances (RoHS)	02.01.2013

GBR Standards	Scope
BS 61010-1:2010	Safety general laboratory equipment
BS 61010-2-010:2020	Safety equipment for the heating of materials
BS 63000:2018	Restriction of hazardous substances (RoHS)

USA Regulations	Scope
47 CFR Part 15 (FCC)	Electromagnetic compatibility (EMC)
17 CFR Parts 240 & 249b	Dodd frank “Conflict minerals”
27 CCR Parts 25102-27001	Proposition 65: The safe drinking water and toxic enforcement act
TSCA 40 CFR Part 751	Toxic substances control act

USA Standards	Scope
UL 61010-1:2012	Safety general laboratory equipment
UL 61010-2-010:2019	Safety heating devices

CAN Standards	Scope
CSA-C22.2 No. 61010-1	Safety general laboratory equipment

CHN Regulations	Scope	Date effective
Order 32/2016	Restriction of hazardous substances (RoHS)	01.07.2016

CHN Standards	Scope
SJ/T 11364-2014	Restriction of hazardous substances (RoHS)

Zizers, 2023-12-08

 Urs Hartmann
 CEO



 Daniela Gross
 Head of Corporate
 Quality

Table of Contents

Chapter 1	Introduction	
	1.1 Symbols used.....	7
	1.2 Functional description and intended use.....	8
	1.3 Safety notes	9
Chapter 2	Description of the device	
	2.1 Scope of delivery.....	11
	2.2 Overview of MEDIACLAVE	13
Chapter 3	Installation	
	3.1 Preconditions	17
	3.2 Unpacking, setting up and moving	18
	3.3 Installation of supplies.....	20
Chapter 4	MEDIACLAVE webserver	
	4.1 Overview of the webserver.....	23
	4.2 Access the webserver	23
	4.3 MEDIACLAVE webserver functions	24
Chapter 5	Process documentation	
	5.1 Overview	26
	5.2 Documentation by webserver.....	26
	5.3 Log file backup to USB flash drive	29
	5.4 Verification of electronically signed log files.....	30
Chapter 6	Parameter settings	
	6.1 Overview MAIN MENU functions	32
	6.2 Configure system parameters	33
	6.3 Overview program definitions.....	38
	6.4 STANDARD mode	39
	6.5 CHOCOLATE AGAR mode.....	41
	6.6 WATER BATH mode.....	43
	6.7 AUTOCLAVE mode (MEDIACLAVE 10 only)	44

Chapter 7	Operation	
	7.1	Preparation steps before and during a process45
	7.2	Run the STANDARD or CHOCOLATE AGAR program 50
	7.3	Run the WATER BATH program55
	7.4	Run the AUTOCLAVE program (MEDIACLAVE 10 only)56
	7.5	Error handling58
Chapter 8	Maintenance	
	8.1	Overview67
	8.2	Daily maintenance69
	8.3	Monthly CLEANING 70
	8.4	DRAINING / FILLING procedure72
	8.5	Checking the safety valve75
	8.6	Checking and replacing pivot pin disk77
	8.7	Changing the printer paper roll78
	8.8	Exchanging the ink ribbon79
	8.9	Shipping to INTEGRA Biosciences80
	8.10	Disposal80
Chapter 9	Technical data	
	9.1	Specification of the devices81
Chapter 10	Accessories and consumables	
	10.1	Accessories84
	10.2	Consumables89
Chapter 11	Appendices	
	11.1	Glossary90
	11.2	Maintenance qualification form94
	11.3	Customer service reply form95
Imprint		96

1 Introduction

These operating instructions contain all information required for installation, operation and regular maintenance of MEDIACLAVE. Furthermore, all important technical data and an overview of available accessories are summarized.

Purpose This chapter informs about the symbols used in these operating instructions, the intended use of the MEDIACLAVE and the general safety instructions.

1.1 Symbols used

1.1.1 Safety alert symbol



SAFETY SIGN

This is the general warning sign. It is used to alert the user to potential personal injury hazards. In addition, hazards for machinery, materials and the environment are possible. All safety messages that follow this sign shall be obeyed to avoid possible harm.

1.1.2 Severity levels of hazards in these operating instructions

The signal word in the top panel designates the hazard severity level.

	<p style="text-align: center;">⚠ DANGER</p> <p>Indicates a hazard with a high level of risk, which, if not avoided, will result in death or serious injury.</p>
	<p style="text-align: center;">⚠ WARNING</p> <p>Indicates a hazard with a medium level of risk, which, if not avoided, could result in death or serious injury.</p>
	<p style="text-align: center;">⚠ CAUTION</p> <p>Indicates a hazard with a low level of risk, which, if not avoided, could result in minor or moderate injury.</p>
	<p style="text-align: center;">NOTICE</p> <p>Means that material damage could occur, if the corresponding precautionary measures are not taken.</p>

1.1.3 Work reference

	<p style="text-align: center;">ASSISTANCE</p> <p>This symbol identifies important notes regarding the correct operation of the device and labor-saving features.</p>
--	---

1.1.4 Hazard warnings on the device



ATTENTION HOT

Risk of burns from the metallic cover of the instrument.

1.2 Functional description and intended use

This is a general-purpose laboratory instrument for use in research only. Any use of this instrument in a medical or IVD setting is the sole responsibility of the user.

The MEDIACLAVE is used in laboratories for the preparation and sterilization of standard as well as highly sensitive media. The MEDIACLAVE operates as a stand-alone device, but can also be combined with the peristaltic pump DOSE IT or the petri dish and tube filler MEDIAJET.

The MEDIACLAVE is available in two different device types:

- The **MEDIACLAVE 10** prepares up to 10 liters of media in about one hour. This versatile nutrient media sterilizer can be easily converted to an autoclave for media sterilization in glassware or a water bath.
- The **MEDIACLAVE 30** is a media sterilizer which prepares up to 30 liters of media in approx. 90 min and provides a function for pre-swelling of media.





This product may only be operated in a secure, protected network with validated, trustworthy clients. The operator must ensure that network security measures are always up-to-date and state-of-the-art. This product may not be directly exposed to the internet.

The MEDIACLAVE must not be used for other purposes than specified in this section. The MEDIACLAVE is not suitable for the sterilization of instruments, glassware or medical devices. If MEDIACLAVE is used in a manner not specified by INTEGRA Biosciences, the protection provided by the MEDIACLAVE may be impaired.

If the safety notes are not followed, INTEGRA Biosciences is not liable for resulting damage.

1.3 Safety notes

	 WARNING
	The MEDIACLAVE is subject to high thermal and compressive stress during the sterilization cycle. It is therefore imperative to observe the safety notes of these operating instructions.

1.3.1 Operation of the MEDIACLAVE



The MEDIACLAVE corresponds to state-of-the-art and recognized safety regulations according to the Declarations of Conformity (independently approved by TÜV SÜD Product Service GmbH). If serviced regularly and if used only for purposes as specified in these operating instructions, the MEDIACLAVE stands for optimal safety and quality.

The MEDIACLAVE may be operated only in flawless condition while observing these operating instructions.

The device may be associated with residual risks if it is used or operated improperly by untrained personnel.

It is imperative to follow all instructions on the display after error notifications. Disregarding them may have serious consequences such as damage to the equipment, damage to property or injury to personnel!

Always wear safety goggles when working with the MEDIACLAVE.

Any person charged with the operation of the MEDIACLAVE must have read and understood these operating instructions, and particularly, the safety notes, or must have been instructed by the supervisors so that safe operation of the device is guaranteed.

Regardless of the listed safety notes, additional applicable regulations and guidelines of the trade associations, the health authorities, and the trade supervisory office, e. g. GLP, GMP, FDA, must be observed.

Please visit our website www.integra-biosciences.com on a regular basis for up to date information regarding REACH classified chemicals contained in our products.

1.3.2 General safety notes



- Do not open the MEDIACLAVE. Do not carry out any conversions and alterations on the device.
- It is **mandatory** that a service is carried out at least once a year or after 1000 sterilization cycles (whatever is reached first) by authorized personnel because the MEDIACLAVE is subject to high thermal and compressive stress during the sterilization cycles. Ask your distributor for support!
- Servicing work, e. g. the replacement of the 0,2 µm sterile filter, and repairs may only be performed by INTEGRA Biosciences or an authorized after-sales service member.
- Defective parts may only be replaced with original INTEGRA Biosciences spare parts according to the INTEGRA Biosciences service instructions.
- The owner/the laboratory is responsible for the MEDIACLAVE qualification, i. e. the installation qualification (IQ), the operation qualification (OQ), the performance qualification (PQ) and the maintenance qualification (MQ). INTEGRA Biosciences will offer support via the local sales representatives.
- Observe the hazard warnings on the device.
- The working environment must be clean, dry, non-condensing and without conductive pollution, i. e. no metallic dust.
- In order to ensure error-free operation of the MEDIACLAVE, the maintenance procedures in the intervals specified must be adhered to and documented.

2 Description of the device

Purpose This chapter describes the most important components of the MEDIACLAVE with its specific terminology.

2.1 Scope of delivery

All required parts of an operable MEDIACLAVE unit are listed below.

MEDIACLAVE 10

<input checked="" type="checkbox"/>	Quantity	Description	Part No.
	1	Stainless steel cuvette MC 10 (installed)	136 030
	1	Magnetic stirrer bar	132 130
	1	Decanting tubing MC 10, complete	136 034
	1	Fitting for dispensing tubing with stainless spring	136 035
	2	Lid seal (one installed)	135 860
	1	Water outlet hose, 2 m length	136 042
	1	Cooling water hose with strainer, 2 m length, fitting 3/4 inch	136 043 136 045
	1	Deaeration hose, 2 m length	136 044
	1	Safety valve maintenance tool (installed)	136 995
	1	Operating instructions	136 950
	1	Check protocol	136 956
	1	T-probe medium semi-rigid 10L (installed)	136 978
	1	USB flash drive to copy log files (installed)	136 068

In addition for MEDIACLAVE 10 with printer:

<input checked="" type="checkbox"/>	Quantity	Description	Part No.
	1	Printer splash guard	136 040

Consumables:

<input checked="" type="checkbox"/>	Quantity	Description	Part No.
	2	Paper rolls, for integrated printer	-
	1	Ink ribbon, for integrated printer	136 901
	1	Pivot pin disk PTFE for cuvette 10/30L (6-pack) with instruction	136 066

MEDIACLAVE 30

<input checked="" type="checkbox"/>	Quantity	Description	Part No.
	1	Stainless steel cuvette MC 30 (installed)	136 060
	1	Magnetic stirrer bar with paddle	136 075
	1	Decanting tubing MC 30, complete	136 061
	1	Fitting for dispensing tubing with stainless spring	136 035
	2	Lid seal (one installed)	135 860
	1	Water outlet hose, 2 m length	136 042
	1	Cooling water hose with strainer, 2 m length, fitting 3/4 inch	136 043 136 045
	1	Coupling water inlet hose	136 062
	1	Deaeration hose, 2 m length	136 044
	1	Printer splash guard	136 040
	1	Safety valve maintenance tool (installed)	136 995
	1	Operating instructions	136 950
	1	Check protocol	136 956
	1	T-probe medium flexible (installed)	136 979
	1	USB flash drive to copy log files (installed)	136 068

Consumables:

<input checked="" type="checkbox"/>	Quantity	Description	Part No.
	2	Paper rolls for integrated printer	-
	1	Ink ribbon	136 901
	1	Pivot pin disk PTFE for cuvette 10/30L (6-pack) with instruction	136 066

Please also refer to the packing list included in the shipment, as the complete scope of delivery is dependent on the respective device type and possible additional accessories (see “10 Accessories and consumables” on page 84).

2.2 Overview of MEDIACLAVE

This section describes the most important components of both device types.

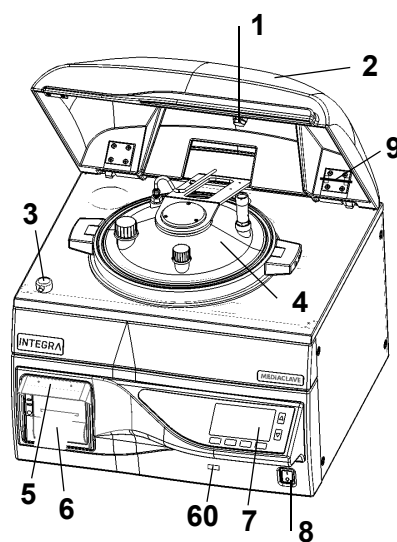

- 1 **Magnet of safety cover**
- 2 **Safety cover**
- 3 **Safety cover lock**
- 4 **Vessel lid**
- 5 **Printer splash guard**
- 6 **Printer**
- 60 **USB port**
- 7 **Operating panel (see 2.2.1)**
- 8 **Main switch**
- 9 **Safety valve maintenance tool**

2.2.1 Operating panel

The MEDIACLAVE is controlled by a graphical user interface with 2 arrow and 4 function keys.

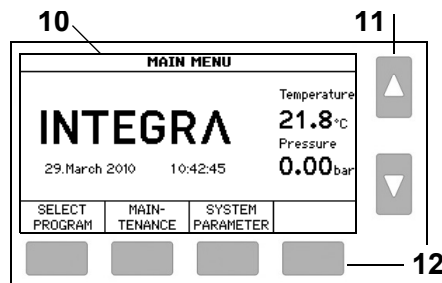

- 10 **Graphical user interface**
- 11 **Arrow keys** to select and adjust parameters
- 12 **Function keys** for selection of menu options

2.2.2 Vessel lid

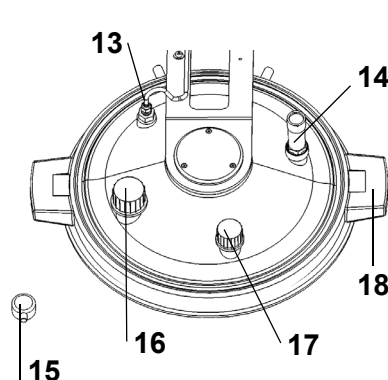

- 13 **PT1000 Temperature probe** for medium, G ¼"
- 14 **Safety valve, G ¼"**
- 15 **Safety cover lock**
- 16 **Adding port, GL32**
- 17 **Dispense port, GL25**
- 18 **Vessel lid grip**

2.2.3 Vessel interior view

MEDIACLAVE 10

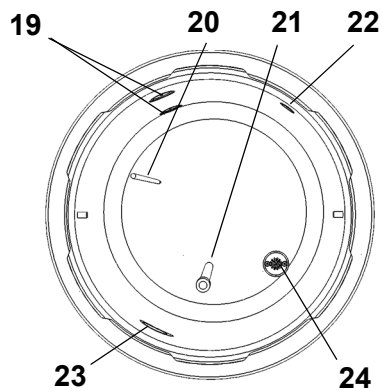

- 19 **Upper and lower coupling water level sensor**
- 20 **PT1000 temperature probe semi-rigid for medium**
- 21 **Decanting tubing (220 mm length for MEDIACLAVE 10)**
- 22 **Opening deaeration and support pressure**
- 23 **Opening coupling water circulation**
- 24 **Drain with water strainer**

MEDIACLAVE 30

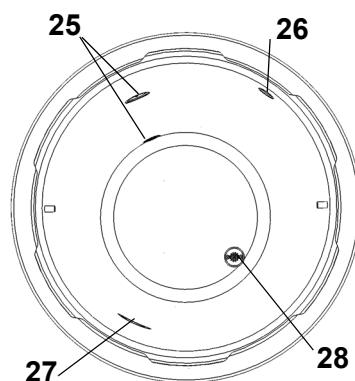

- 25 **Upper and lower coupling water level sensor**
- 26 **Opening deaeration and support pressure**
- 27 **Opening coupling water circulation**
- 28 **Drain with water strainer**

2.2.4 Cuvette interior view

MEDIACLAVE 30

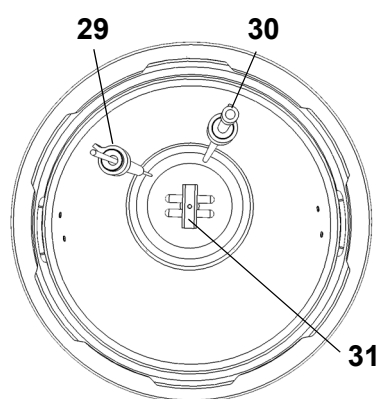

- 29 **PT1000 temperature probe flexible for medium with fixing**
- 30 **Decanting tubing with fixing**
- 31 **Magnetic stirrer bar**

2.2.5 Rear panel

	WARNING
The deaeration hose and the cooling and coupling water hose may get hot. There is a risk of burns. Always wear oven gloves when touching the hoses.	

MEDIACLAVE 10

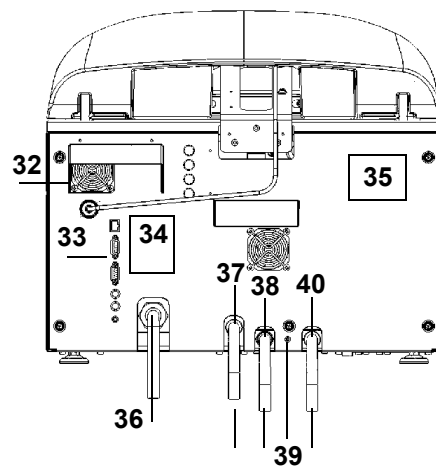

- 32 Fan
- 33 Interfaces
- 34 Connection chart
- 35 Type plate
- 36 Power supply
- 37 Deaeration outlet port
- 38 Cooling water inlet port
- 39 Cooling water throttle (+: counterclockwise)
- 40 Water outlet port (for cooling and coupling water)

MEDIACLAVE 30

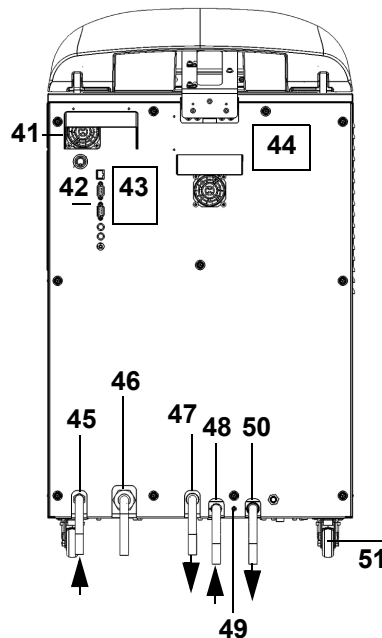

- 41 Fan
- 42 Interfaces
- 43 Connection chart
- 44 Type plate
- 45 Coupling water inlet port
- 46 Power supply
- 47 Deaeration outlet port
- 48 Cooling water inlet port
- 49 Cooling water throttle (+: counterclockwise)
- 50 Water outlet port (for cooling and coupling water)
- 51 Wheel

2.2.6 Rear panel interfaces

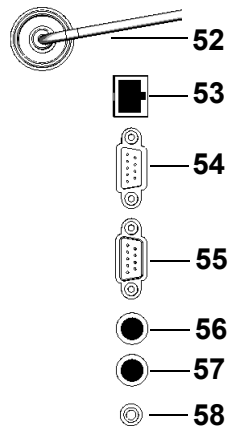

Interface	Function
52 PT1000	Connection for the PT1000 temperature probe
53 Ethernet	Ethernet 10/100 connection
54 RS232 (male)	Serial interface external protocol printer
55 RS232 (female)	Serial interface MEDIAJET
56 Ext. pinch valve	Connection for controlling an external pinch valve, 24 V DC, max. 15 W
57 AUX	Potential free output. Spare, i.e. cannot be used for e.g. an external alarm!
58 Foot switch	Connection for the foot switch

2.2.7 Front panel interface

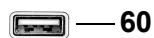

Interface	Function
60 USB port	USB flash drive connection

3 Installation

Purpose This chapter defines the operating environment and describes the unpacking and installation of MEDIACLAVE.

3.1 Preconditions



3.1.1 Operating environment

The following criteria must be considered in choosing an appropriate operating environment:



Criteria	Range
Ambient temperature for operation	5–40 °C
Maximum relative humidity	Non-condensing, 80 % for temperatures up to 31 °C decreasing linearly to 50% relative humidity at 40 °C
Altitude	0–2000 m AMSL
Voltage fluctuations of the mains supply	+/-10 % from the nominal value
Degree of pollution 2 as per IEC EN/UL 61010-1	Normally only non-conductive pollution occurs. Occasionally, however, a temporary conductivity caused by condensation must be expected

If the operating environmental criteria are not within the range as outlined, the functional capability and safety cannot be guaranteed.

3.1.2 Installation location

	 WARNING
	The MEDIACLAVE must only be set up on a cleaned, dry and horizontal surface. For MEDIACLAVE 10 the bench must be capable of supporting a minimum weight of 80 kg. The MEDIACLAVE 30 must be set up on the floor.

Generally inadmissible are locations where there is a risk of spray water or of contact with potentially hazardous chemicals. For user convenience, the front of the instrument must be always accessible. Leave sufficient space behind the device to allow easy connection of the mains cable and water hoses.

	 CAUTION
	Allow at least 10 cm on both sides for free air circulation. In error case, hot steam may be released from the safety valve at the top of the vessel lid, mainly to the rear side and also on the side of the device. There is the risk of burns. Protect this area against access.

The MEDIACLAVE satisfies the form of protection IP 21 as per IEC 60529.

The instrument must be located within easy reach of power sockets, tap water supply and drain.

Provisions must be made to run the water outlet hose and the deaeration hose at the rear of the instrument into the drain. The deaeration hose must be positioned lower than the MEDIACLAVE over its whole length in prevention of back pressure. For correct position of the hose see “3.3.1 Cooling and coupling water supply” on page 20.

3.2 Unpacking, setting up and moving

The instrument packing has been carefully designed to prevent damage to the MEDIACLAVE during rough shipping.

- ▶ Remove all transport moorings. Unpack the cardboard box from the MEDIACLAVE.

	ASSISTANCE
	Check the scope of delivery for any transport damage (see <u>“2.1 Scope of delivery”</u> on page 11) and notify your local INTEGRA Biosciences AG representative (see <u>“Imprint”</u> on page 96).

3.2.1 Setting up MEDIACLAVE 10

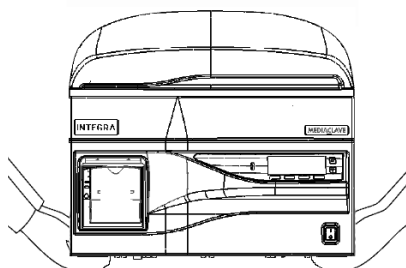

- ▶ At least two persons are required to lift the instrument. Lift the instrument holding it steady and firmly at the base of both sides beside the feet. Never lift the instrument by the cover handle or the front.
- ▶ Set up the basic device on the bench or floor respectively. In order to obtain a horizontal alignment of the **MEDIACLAVE 10**, adjust the height of the equipment feet with a 13 mm flat spanner.

	ASSISTANCE
	To reduce the dead volume of the media during dispensing it is recommended to incline the MEDIACLAVE 10 up to 0.5 cm at the rear.

- ✓ The **MEDIACLAVE 10** is set up.

	CAUTION
	After first setting up and moving of the MEDIACLAVE 10 , the accomplishment of an Installation Qualification procedure by a qualified service technician is strongly recommended! Otherwise, there is the risk of insufficient sterilization and a safe operation is not guaranteed.

Before moving the **MEDIACLAVE 10**, it must be cooled down, emptied (see “8.4.1 Draining the coupling water system” on page 72) and unplugged from the electricity mains. Remove any items from the top of the instrument. Close the vessel lid and the safety cover. Disconnect all cables and water hoses.

3.2.2 Setting up MEDIACLAVE 30

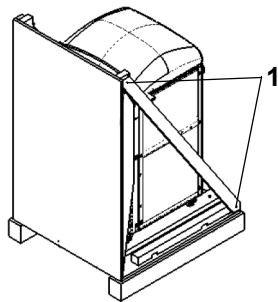

- ▶ Unscrew the diagonal wood laths on both sides (1) with a T20-Torx screw driver.
- ▶ Remove the two slacked belts.
- ▶ Place the front plate in front of the pallet, so that it can be used as a ramp. Fix the ramp with the pallet by the fastener (2).

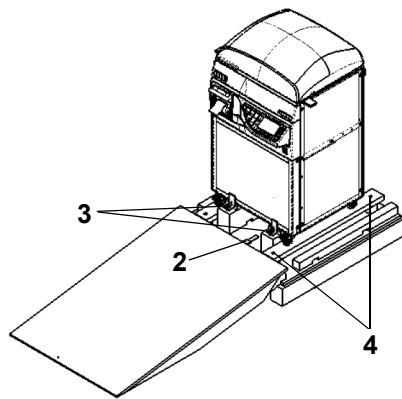

- ▶ Unscrew the wing screws (3) of the elbow fittings and remove them.
- ▶ Move up the tracks for the **MEDIACLAVE 30** wheels by turning the four screws (4) with a 5 mm hex-wrench (Allen key).
- ▶ One person on each side is required to wheel the **MEDIACLAVE 30** down onto the floor.
- ▶ Wheel the device to the desired place. Set the packing aside for re-shipping.

✓ The **MEDIACLAVE 30** is set up.

	⚠ CAUTION
<p>After first setting up of the MEDIACLAVE 30, the accomplishment of an Installation Qualification procedure by a qualified service technician is strongly recommended! Otherwise, there is the risk of insufficient sterilization and a safe operation is not guaranteed.</p>	

For moving disconnect the **MEDIACLAVE 30** from the electricity mains. Close the safety cover and disconnect the hoses. Release the stopper of the wheels and move the **MEDIACLAVE 30** to the desired place. Put on the stoppers and connect the device to the electricity mains.

3.3 Installation of supplies

3.3.1 Cooling and coupling water supply

For technical specifications please refer to chapter 9. Consult the local regulations before connecting the MEDIACLAVE to the drinking-water supply.

To connect the MEDIACLAVE to the cooling water supply, read the label at the rear panel and proceed the following steps:

- ▶ Connect the cooling water hose to the corresponding inlet and to the water tap.
- ▶ Adjust the water flow by selecting the program “Check cooling water flow” under the menu **SYSTEM PARAMETER - USER EXTRAS** as follows:

Utilities		MEDIACLAVE 10	MEDIACLAVE 30
Cooling water flow rate	5°C	1.5 L/min	2.5 L/min
	15°C	1.8 L/min	3.0 L/min
	25°C	2.3 L/min	3.8 L/min

COOL WATER FLOW			
▶ Press and hold PRIME to fill system with water			
▶ Press START to open cooling valve for 10 sec. Point hose into a graduated cylinder (recommended 2 L volume).			
START	PRIME		BACK

COOL WATER FLOW			
▶ Check if the water volume is within the limits: 0.27 ... 0.33l (1.8l/min) at 15°C			
▶ If the measured water volume is not within the limits, adjust the cooling water throttle and press AGAIN to repeat measurement.			
OK	AGAIN		

- ▶ Put the end of the water outlet hose into a container and open the water tap.
- ▶ Press PRIME until water pours out of the water outlet hose.
- ▶ Point the water outlet hose into a graduated cylinder and press START.
- ▶ For adjusting insert a hex screw driver (2.5 mm) into the opening of the cooling water throttle and turn it:
 - +: counterclockwise
 - : clockwise.
 Try with one turn, then approach to the target.

	⚠ CAUTION
	MEDIACLAVE 30: Coupling water supply must be equipped with a manual stop cock. This stop cock must be manually closed all the time except when the coupling water is filled in.

- ✓ The MEDIACLAVE is connected to the water supply.

3.3.2 Deaeration and water outlet hoses

	NOTICE
	A drain is required below instrument level (MC 10) or floor level (MC 30).

- ▶ Connect the water outlet hose to the water outlet port.
- ▶ Connect the deaeration hose to the deaeration outlet port.

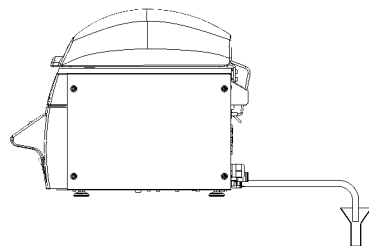

- ▶ Let the hoses hang straight downwards - without any upward bending - into the lower lying water drain opening. Water must not accumulate within the hoses and their ends must not submerge into the water, but must freely hang over the water drain.
- ▶ Fix the hoses within the drain.

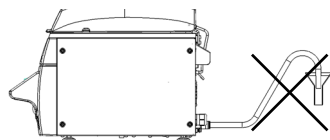

no upward bending

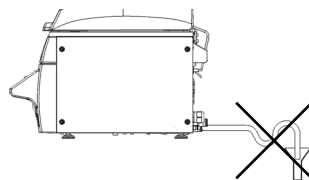

no upward bending

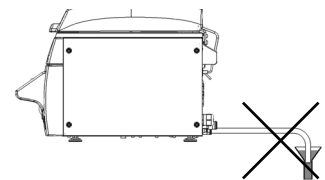



no submerge into water



- ▶ Prevent that the steam from the deaeration hose gets near the fan air inlet (see “2.2.5 Rear panel” on page 15, numbers 32 or 41). The end of the deaeration hose and water drain must be placed in a sufficient distance to the fan air inlet. Alternatively, put a plastic deflector in front of the deaeration hose blocking the steam from getting near the fan.
- ✓ The MEDIACLAVE deaeration and water outlet hoses are connected to the drain.

	NOTICE
	For an error-free deaeration of the instrument, back pressure in the water outlet hose and in the deaeration hose must be avoided. Otherwise, the sterilization temperature can not be reached and the medium batch must be discarded. Carefully follow the instructions for connecting the cooling water outlet hose.

3.3.3 Electricity supply

	 WARNING
	<p>In case of visible condensation on the device, there is the risk of electric shock. Wait 24 h. Check whether the instrument is dry before connecting to the electricity supply.</p>

Before connecting the instrument to the electricity supply, ensure that the network voltage and fuse rating are compatible to that indicated on the instrument type plate at the rear of the instrument, see [“2.2.5 Rear panel”](#) on [page 15](#), and are according to local standards.

	 WARNING
	<p>In order to avoid damage to users and laboratory, it must always be possible to manually disconnect the MEDIACLAVE from electricity supply.</p> <p>a) MEDIACLAVE 10 with a separable plug: Label the corresponding socket clearly as the disconnecting device of the MEDIACLAVE. The socket shall be in close proximity to the MEDIACLAVE and within easy reach of the operator.</p> <p>b) MEDIACLAVE 10 and MEDIACLAVE 30 without plug: A switch or circuit breaker shall be provided in the laboratory for disconnecting all current-carrying conduction. It shall be in close proximity to the MEDIACLAVE and within easy reach of the operator. It shall be labelled as the disconnecting device of the MEDIACLAVE. The instrument may only be connected by a qualified service technician according to the service instructions.</p>

▶ Connect the electricity cable to the fully grounded electricity mains.

✓ The device is now fully assembled.

▶ Switch on the device, see main switch [“2.2 Overview of MEDIACLAVE”](#) on [page 13](#).

▶ Wait until the device has completed the automatic software initialization.

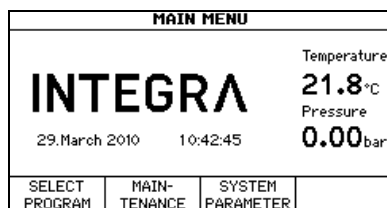

✓ When the **MAIN MENU** with the INTEGRA Biosciences logo appears on the screen, the device is initialized and is ready for use.

4 MEDIACLAVE webserver

Purpose This chapter describes the features and how to access the MEDIACLAVE webserver.

4.1 Overview of the webserver

The MEDIACLAVE provides a webserver with various functions, e.g. MEDIACLAVE monitoring or recording process data into log files. To use this software permanently, a connection of the MEDIACLAVE with a network computer is required. For temporary use, the MEDIACLAVE can be connected directly to a personal computer via a crossed ethernet cable.

Four functions are accessible on the MEDIACLAVE webserver:

- Main Menu: Shows the current MEDIACLAVE display on the personal computer.
- Log Files: To view and download all log files.
- Process Diagram: Displays a detailed diagram of the current operating status (heater, valves, etc.) and sensor values of the MEDIACLAVE during process.
- Service: For service technicians only.

4.2 Access the webserver

4.2.1 Network connection

Ask your network administrator for a valid IP address, subnet mask and standard gateway to connect the MEDIACLAVE to the laboratory network. Enter these data in the MEDIACLAVE Webserver menu (see [“6.2 Configure system parameters”](#) on page 33).

You can now access the MEDIACLAVE with an internet browser on a computer in the same network as follows:

- ▶ Start up the internet browser on the computer.
- ▶ Enter the MEDIACLAVE IP address provided by the network administrator in the internet browser address line, e.g. `http://192.168.0.1` and press enter.

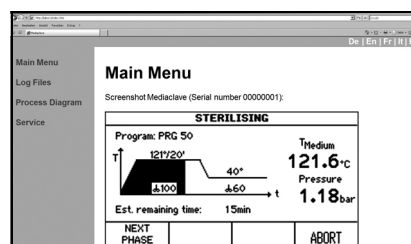

- ✓ The webserver **Main Menu** should appear in your browser window, showing the current content of the MEDIACLAVE display.
- ▶ In the top right of the screen you can switch the language of the web interface.

4.2.2 Temporary connection to a personal computer

The MEDIACLAVE can be directly connected to a computer by means of a crossed ethernet cable. For a successful connection, the IP address and the subnet mask must be set correctly on the computer and on the MEDIACLAVE.

- ▶ Acquire the network settings of the computer. Note down the IP address and the subnet mask of the computer (see example below).
- ▶ To set the network interface on the MEDIACLAVE, navigate to the Menu **SYSTEM PARAMETER** and **WEBSERVER**. Enter the subnet mask of the computer. Enter an IP address differing from the computer IP address in the last digit.
- ▶ You may now access the MEDIACLAVE webserver with a browser by entering the IP address of the MEDIACLAVE in the address line.

	ASSISTANCE
	This description applies only for the connection of an already running personal computer. The IP address is lost when the computer is switched off. For a constant connection, a fix IP address must be used. Please contact your network administrator (see 4.2.1).

Example:

The following procedure applies to PCs running under Microsoft Windows. The first step is slightly different for computers running under other operating systems, e. g. Mac OS.

- ▶ Click Menu “Start” - “Settings” - “Network connection” and double click on the LAN connection used for access to MEDIACLAVE. The status windows opens. Switch to the register “Network Support”. Note down the PC network settings, e.g. IP Address 10.4.7.3, Subnet Mask 255.255.0.0
- ▶ Set the MEDIACLAVE webserver to following values: IP Address 10.4.7.4, Subnet Mask 255.255.0.0 (last digit of IP Address different from PC network).
- ▶ Open the Internet Explorer, enter http://10.4.7.4 in the address line.
- ✓ The MEDIACLAVE Main Menu (see [4.2.1](#)) should appear.

4.3 MEDIACLAVE webserver functions

Access the MEDIACLAVE webserver by entering the IP address of the MEDIACLAVE in the address line of a PC browser, see [“4.2 Access the webserver” on page 23](#). Click on the list on the left margin to open one of the four windows.

4.3.1 Main Menu

In the **Main Menu** the current MEDIACLAVE display is shown. This feature can be used for monitoring the MEDIACLAVE via a personal computer without need of standing in front of the MEDIACLAVE.

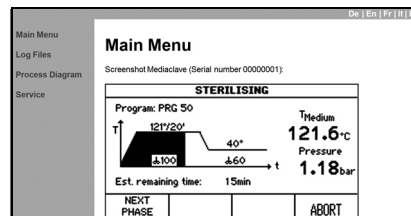

- ▶ If you want to save the current display as a bitmap, make a right mouse click on it and select “Save picture”.

4.3.2 Log Files

In the **Log Files** Menu the log files of the last 10 processes are listed. In addition, the “System Logfile”, the “Device Parameters” file with all stored device and user settings and the “Key for signature verification” (pubkey.txt) for the verification of electronically signed log files are accessible.

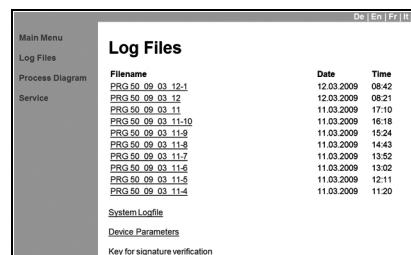

- ▶ To open a file click on it. For saving select “File” in the menu bar and “Save as”.

4.3.3 Process Diagram

The **Process Diagram** shows a detailed diagram of the current MEDIACLAVE status with measured sensor values.

	ASSISTANCE
Viewing of the process diagram requires that your browser supports SVG graphics and JavaScript is activated.	

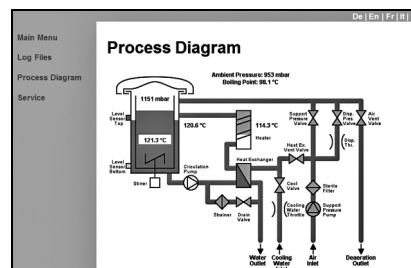

- ▶ This process diagram supports the service technician.

4.3.4 Service

This menu is supporting the service technician and requires authorization.

5 Process documentation

Purpose This chapter describes how to document the process-relevant data electronically.

5.1 Overview

The MEDIACLAVE provides three methods for process documentation and diagnostic purposes:

- Protocol printer (MEDIACLAVE versions with printer only or external printer, see [“6.2.2 Process documentation by printer”](#) on page 34).
- Webserver, see [“5.2 Documentation by webserver”](#) on page 26.
- USB flash drive, see [“5.3 Log file backup to USB flash drive”](#) on page 29.

There are four types of log files:

- Run data log files: e. g. RUN00058.LOG
- System Logfile (logbook): SYSTEM.LOG
- Device parameters log file: PARAM.LOG
- Program log file: PROGRAM.LOG

5.2 Documentation by webserver

For each run the device creates a run data log file. It is signed, if the log file signature is switched ON in the **WEBSERVER** window of the MEDIACLAVE **SYSTEM PARAMETER** menu (see [“6.2 Configure system parameters”](#) on page 33). The process data are documented in the log file every 10 seconds independently from the recording rate defined for the printer in the **PROCESS DOCUMENTATION** window.

For reading or downloading the log files, access the MEDIACLAVE webserver, see [“4.2 Access the webserver”](#) on page 23.

Filename	Date	Time
PRG 50_09_03_12-1	12.03.2009	08:42
PRG 50_09_03_12	12.03.2009	08:21
PRG 50_09_03_11	11.03.2009	17:10
PRG 50_09_03_11-10	11.03.2009	16:18
PRG 50_09_03_11-9	11.03.2009	15:24
PRG 50_09_03_11-8	11.03.2009	14:43
PRG 50_09_03_11-7	11.03.2009	13:52
PRG 50_09_03_11-6	11.03.2009	13:02
PRG 50_09_03_11-5	11.03.2009	12:11
PRG 50_09_03_11-4	11.03.2009	11:20

► In the list on the left margin, click on **Log Files**.

- ✓ The log files of the last 10 runs are displayed. The latest log file is listed on the top, the oldest on the bottom.

After 10 runs, the oldest log file will be overwritten by the latest. The file name consists of RUN followed by the 5-digits cycle number, e. g. RUN00234.LOG (cycle no. 234).

For easy integration with LIMS, the log files can also be downloaded via FTP. Please contact your local service technician for details. The log file looks as follows:

Example of run data log file

```
-----BEGIN PGP SIGNED MESSAGE-----
Hash: SHA1
*****
MEDIACLAVE (SN:00000006)
***Start process
Lot-No:          3L MEDIUM
Time:            15:25:38
Date:           26.08.2008
Cycle No:       22

***Program parameter
Number:         02
Name:           DBA 01
Op. mode:      MEDIACLAVE
Steri. T:       121°C
Steri. t:       10min
Steri. stirrer: 200rpm
Disp. T:        50°C
Disp. stirrer:  100rpm
Alt. rotating dir.: ON
Min. heat. water T: 30°C
*****

***Heating
50.4°C - 15:25:38,50.3,49.8,0,16911360
...
120.9°C - 15:44:18,121.4,123.3,1411,16910340

***Sterilization
Start: 15:44:22
121.0°C - 15:44:22,121.4,123.7,1414,16910340
121.2°C - 15:44:32,121.6,123.7,1411,16910340
...
121.5°C - 15:54:12,121.5,120.1,1229,16910340
121.5°C - 15:54:22,121.5,120.1,1222,16910340
End: 15:54:22

***Cooling
121.5°C - 15:54:32,121.4,119.9,1287,16910420
...
51.3°C - 16:03:42,50.7,44.8,0,16910404

***Dispensing
50.7°C - 16:04:01,50.3,46.2,0,16910414
...
49.4°C - 16:06:31,49.4,51.1,16,20056140
***End process

*****
Sterilization OK
*****
```

Example of run data log file

```
User: _____  
-----BEGIN PGP SIGNATURE-----  
iEYEAARECAAYFAki0KhAACgkQBDAzyh4A5R0mbgCfXwmmYnB5o35pIxYeypGa8LW  
v70AoIUxY/usbAtaKKlyBXWcSSSHOjac=bhRB  
-----END PGP SIGNATURE-----
```

In every line containing temperature and date information, numbers are added and separated by commas, representing device status information.

5.2.1 Log file backup to PC

The webserver backup tool helps to archive the stored log files from the MEDIACLAVE to a personal computer. Running the backup tool will automatically save the last 10 log files to your backup directory on your personal computer.

Download the log file backup tool (ZIP) from the **Log Files** Menu of the MEDIACLAVE (Software version: 01.11 and Webserver version: 01.02 or higher required) and follow the instructions on the readme text file. See also [“6.2.3 Process documentation by webserver”](#) on page 36.

5.3 Log file backup to USB flash drive

There are two methods for saving log files to a USB flash drive:

- a) Automated to document Run data files, e.g. RUN00058.LOG, see also [“6.2.4 Process documentation to USB flash drive”](#) on page 36.
- b) Manual to save all log files, e.g. RUN00058.LOG (to max. last 10 runs) and PARAM.LOG, PROGRAM.LOG and SYSTEM.LOG for diagnostic purposes in case of an error, see also [“6.2.5 Saving all log files to USB flash drive”](#) on page 36.

The file structure is created as follows:

File structure	Explanation
Drv:	Drive letter, e.g. removable media F:
—MC10	Device type
—09010101	8-digits MC 10 serial number
—RUN	Automated backup:
—RUN00001.LOG	Collection of runs when process documentation is enabled under system parameter and USB flash drive is connected. Attention: PARAM.LOG, SYSTEM.LOG and PROGRAM.LOG are not saved!
—RUN00002.LOG	
—RUN00003.LOG	
—...	
—12_02_22	Manual backup: Date of first run: YY_MM_DD
—PARAM.LOG	Parameters log file
—PROGRAM.LOG	Program files
—RUN00058.LOG	Run log files: RUNxxxxxx (5-digits)
—...	...
—RUN00067.LOG	last 10 runs per day
—SYSTEM.LOG	System log file
—12_02_25	Date of last run: YY_MM_DD
—...	
—11030240	MC 10 serial number (second unit)
—12_02_23	Date of first run: YY_MM_DD
—...	
—12_02_24	Date of last run: YY_MM_DD
—...	
—MC30	Same as for MC 10

5.3.1 Automated backup to USB flash drive

Log files can be saved automatically if an USB flash drive is connected prior to starting a run. To activate this feature, “Save to USB flash drive” within the system parameter process documentation must be enabled.

The following directory structure is created: device type, serial number and RUN, e.g. G:\MC10\RUN\. The log files (RUNxxxxx.LOG) are saved automatically, where xxxxx stands for the cycle number. The files will not be overwritten except a file of identical name already exists.

5.3.2 Manual backup to USB flash drive

In case of an error the manual backup is a very helpful diagnostic aid that minimize down time. In addition to the Run log files RUNxxxxx.LOG, PARAM.LOG, SYSTEM.LOG and PROGRAM.LOG are saved.

The MEDIACLAVE creates the following directory structure: device type, serial number and date (YY_MM_DD), e.g. G:\MC10\09010101\ 12_02_23\.

	ASSISTANCE
	Log files are very helpful for troubleshooting and diagnosis. For analysis purposes ALL log files are required. Use the manual backup!

5.4 Verification of electronically signed log files

The MEDIACLAVE provides the feature of digitally signed log files as a tamper protection of downloaded files. The signed log files fully comply with FDA (21 CFR Part 11) and EU (GMP Annex 11) directives requirements for electronic process documentation. To activate the generation of the signature, navigate to the MEDIACLAVE **SYSTEM PARAMETER** and **WEBSERVER** menu and set the log file signature to “ON”.

A signed log file can be recognized by a short header specifying the signature algorithm and a section at the end of the file containing the current signature, see example above. A log file is only signed after the associated process has been completed.

The MEDIACLAVE uses the SHA algorithm as specified by U.S. Department of Commerce, National Institute of Standards and Technology (NIST), Information Technology Laboratory (ITL) for calculating the digital signature.

The unique signature is calculated from the log file with the aid of a public key as well as a secret key only known to the MEDIACLAVE. The public key which is needed for log file verification can be downloaded directly from your MEDIACLAVE (see “4.3.2 Log Files” on page 25).

The digital signature makes it possible to verify that log files have not been manipulated. The signed log file can be verified with a wide range of commercial software e.g. PGP or freeware tools from the gpg toolchain (www.gnupg.org). We recommend the following freeware tools (for the latest tested freeware version ask your local distributor):

Tool	Description
GnuPG 2.2.19	Core encryption and signature verification tool, command line execution.
Gpg4win 3.1.11	A key manager and helper for various encryption matters, Microsoft windows GUI.

The following short instruction should assist you in verifying a log file with “Gpg4win 2.3.3” (www.gpg4win.org) or higher. A verification is only possible, if the log file is actually signed!

- ▶ Create a folder, e. g. “verification” on your PCs local disk “C:”.

- ▶ Open the **Log File** Menu of the MEDIACLAVE webserver and download the “Key for signature verification” (e.g. “pubkey.txt”) and the log files to be verified on the created folder of your PC, see “4.3.2 Log Files” on page 25.
- ▶ Open the internet explorer and go to www.gpg4win.org and download the current version of Gpg4win. To install the tool, click on the loaded file (“gpg4win-3.1.11 exe” or a newer version) and follow the instructions on the screen.
- ▶ Click on the “Start” menu of the footer menu bar of your PC and select “Programs” - “GnuPG For Windows” - “GPA”. The GNU Privacy Assistant opens.
- ▶ Create your personal code with code information, e-mail address and password.
- ▶ Select “Keys” - “Import keys” and import the public key for signature verification from your created folder.
- ▶ Sign the public key: Select the key, click on the “Sign” menu and enter your password.
- ▶ Select the window “Files” to switch to the “file manager” window.
- ▶ Open the file to be verified with “File” - “Open” and click on “Verify”.
- ✓ GPA will report whether the file is authentic (Status: valid) or if it has been manipulated (Status: bad).

6 Parameter settings

Purpose This chapter describes how to configure the general device settings and how to program a media preparation, thermostating or autoclaving process.

6.1 Overview MAIN MENU functions

MAIN MENU			
INTEGRA		Temperature	21.8°C
		Pressure	0.00 bar
29.March 2010 10:42:45			
SELECT PROGRAM	MAIN-TENANCE	SYSTEM PARAMETER	

In the MEDIACLAVE **MAIN MENU**, three menu options are accessible by the function keys.

- **SELECT PROGRAM:** To adapt, store (see [“6.3 Overview program definitions” on page 38](#)), as well as execute (see [“7 Operation” on page 45](#)) up to 50 individual programs.
- **MAINTENANCE:**
 - To automatically clean the MEDIACLAVE (see [“8.3 Monthly CLEANING” on page 70](#)),
 - to drain or fill the vessel (see [“8.4 DRAINING / FILLING procedure” on page 72](#)),
 - to drain the cuvette (see [“8.4.2 Draining the cuvette” on page 73](#)) or
 - to perform a functional test of the safety valve [“8.5 Checking the safety valve” on page 75](#).
- **SYSTEM PARAMETER:** To configure the general device parameters (see [“6.2 Configure system parameters” on page 33](#)).

6.2 Configure system parameters

The following table gives an overview of the parameters to be set in the menu option **SYSTEM PARAMETER**. All parameters can be printed out under **USER EXTRAS** (English only).

System parameter	Description and function	Default setting
Language selection	Sets the desired language.	English
Time/Date	Sets the local time and date.	01.01.2000
Display contrast	Alters the display contrast.	50%
Process documentation	Sets the recording rate of printing the process data on MEDIACLAVE, i. e. heating/cooling, sterilization/ boiling, dispensing/supplementing, and the printing direction (see more in “6.2.2 Process documentation by printer” on page 34). Enables/disables the automatic backup of the log files to a USB flash drive, see “6.2.4 Process documentation to USB flash drive” on page 36.	1 min 1 min 1 min STANDARD OFF
USB flash drive	Copies the last 10 run data log files, the system log file and the device parameters file to the USB flash drive, see “6.2.5 Saving all log files to USB flash drive” on page 36.	-
Sterilization parameter	Adjusts sterilization tolerance (0.5-3.0 °C). The sterilization timer runs only when the actual temperature is within or above the defined sterilization tolerance. If the actual temperature is below the tolerance band, the timer is paused.	1.5 °C
Pressure unit	Changes the pressure unit settings (bar or kPa).	bar
Webserver	Provides settings for the ethernet interface, i. e. IP address, subnet mask, standard gateway and log file signature (ON, OFF), see more in “6.2.3 Process documentation by webserver” on page 36.	192.168.0.1 255.255.255.0 192.168.0.254 OFF

System parameter	Description and function	Default setting
Access code	Provides user access restrictions to parameters, if ON, and the access code definition, (see more in “6.2.6 Access code” on page 37).	OFF 3473
System messages	Displays device status information.	-
Info	General information on the device: <ul style="list-style-type: none"> • Software and mainboard version • Device type and serial number • Operating hours and cycle counter. • Service reminder • Safety valve reminder 	depending on the device
User extras (Engl.)	Special features: <ul style="list-style-type: none"> • Logbook (view/print) • Printout device parameters • Check cooling water flow 	-

6.2.1 Language selection

Navigate to **SYSTEM PARAMETER** and **LANGUAGE SELECTION**.



- ▶ Select a language and press SAVE.
- ✓ The screen will appear in the language selected.

6.2.2 Process documentation by printer

The MEDIACLAVE enables the documentation of all process-relevant data with the - for **MEDIACLAVE 10** optional - built-in printer. Alternatively, an external serial printer can be connected to the MEDIACLAVE (see [“2.2.6 Rear panel interfaces”](#) on page 16). INTEGRA Biosciences recommends the EPSON TM-U220 matrix printer.

The serial number of the MEDIACLAVE, the lot number, time, date, cycle number, program parameter, error messages and the starting time of every phase (with temperature) are printed by default (see example on next page). In addition, the printing intervals can be defined for different phases, e. g. every 2 minutes.

PROCESS DOCUMENTATION			
Date recording rate:			
Heating / cooling:	1min		
Sterilisation / boiling:	1min		
Dispensing / supplementing:	1min		
Printing:	STANDARD		
PRINTER TEST		CHANGE	BACK

- ▶ Navigate to **SYSTEM PARAMETER** and **PROCESS DOCUMENTATION**.
- ▶ Use the arrow keys to select the parameter to be changed and press **CHANGE**.
- ▶ Enter the desired value and press **SAVE**.
- ✓ The recording rate is defined.

In the **PROCESS DOCUMENTATION** window the printing direction is selectable:

- **STANDARD**: first entry at the bottom of printout, readable during printing.
- **BACKWARDS**: first entry at the top of printout, printing upside down.
- **OFF**: no printout during processing.

CHANGE PARAMETER			
Printer settings: BACKWARDS			
OFF or STANDARD / BACKWARDS printing direction			
←	→	SAVE	BACK

- ▶ Select **Printing** and press **CHANGE**.
- ▶ Select the desired value for the **Printer settings** and press **SAVE**.
- ✓ The process data will be printed as defined.

The following data is printed out (example printing direction **BACKWARDS**):

When starting the process	During heating and sterilization	Completion of the process
***** MEDIACLAVE (SN:00000002) ***Start process Lot-No: _____ Time: 13:35:23 Date: 20.03.2008 Cycle No: 250 ***Program parameter Number: 01 Name: PRG 01 Op. mode: STANDARD Steri. T: 121°C Steri. t: 20min Steri. stirrer: 150rpm Disp. T: 50°C Disp. stirrer: 100rpm Alt. rotating dir.: OFF Min. heat. water T: 45°C *****	***Heating 25.6°C - 13:35:23 43.4°C - 13:40:23 71.6°C - 13:45:23 95.1°C - 13:50:23 111.5°C - 13:55:23 ***sterilization Start: 14:00:14 121.0°C - 14:00:14 121.3°C - 14:02:14 121.4°C - 14:04:14 121.4°C - 14:06:14 121.1°C - 14:08:14 121.2°C - 14:10:14 121.3°C - 14:12:14 121.4°C - 14:14:14 121.1°C - 14:16:14 121.1°C - 14:18:14 121.2°C - 14:20:14 End: 14:20:14	***Cooling 121.2°C - 14:20:14 70.2°C - 14:25:14 ***Dispensing 51.0°C - 14:28:10 50.4°C - 14:30:10 50.5°C - 14:32:10 50.4°C - 14:34:10 50.2°C - 14:36:10 50.1°C - 14:38:10 50.2°C - 14:40:10 50.2°C - 14:42:10 ***Process aborted 50.2°C - 14:42:36 ***End process ***** Sterilization not OK ***** User: _____

For error notification, a special string is printed as suffix to the temperature line:

String	Description
T	Is printed out, if the sterilization temperature is below the defined sterilization tolerance band.

For a test print, press **PRINTER TEST** in the **PROCESS DOCUMENTATION** window.

```

*****
MEDIACLAVE (SN:12345678)
***Test Printout
LEFT                RIGHT
123456789012345678901234
*****
    
```

6.2.3 Process documentation by webserver

The MEDIACLAVE enables the documentation of all process-relevant data with the built-in webserver that creates log files of every process, see [“5.2 Documentation by webserver” on page 26](#). The process log files can be protected from tampering by a digital signature. To activate the generation of the signature, navigate to **SYSTEM PARAMETER** and **WEBSERVER** and set the log file signature to “ON”.

6.2.4 Process documentation to USB flash drive

The MEDIACLAVE enables the electronic storage of process data to a USB flash drive. Navigate to **SYSTEM PARAMETER** and **PROCESS DOCUMENTATION** and enable “Save to USB flash drive” to activate this feature. Insert a USB flash drive to the USB port on the front panel (60) before switching on the MEDIACLAVE. See also [“5.3.1 Automated backup to USB flash drive” on page 29](#).

6.2.5 Saving all log files to USB flash drive

In an error case save the last 10 process log files (RUNxxxxx.LOG), the system log file (SYSTEM.LOG) and the device parameters file (PARAM.LOG) and (PROGRAM.LOG) to a USB flash drive. Insert the flash drive to the USB port on the front panel (60) of the MEDIACLAVE and navigate to **SYSTEM PARAMETER** and **USB FLASH DRIVE**. Press **START** to copy all files to the USB flash drive. See also [“5.3.2 Manual backup to USB flash drive” on page 30](#).

Be prepared to send all log files to your local service technician if required. This will help to make troubleshooting more efficient and to keep downtime to a minimum.

6.2.6 Access code

The MEDIACLAVE system and program parameter settings can be protected by a code, if activated (Access code required ON). Before any parameter changes can be performed, an access code must be entered. A standard user can only run defined programs.

- ▶ Open the **ACCESS CODE** window and enter the default access code “3473” by typing the appropriate key until the correct number appears on the screen. Press SAVE.

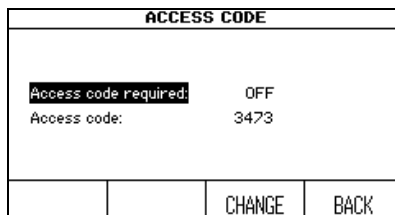

- ▶ Select the line “Access code required” and press CHANGE. Use the arrow keys to select “Access code required: ON”.

- ▶ For changing the Access code select this line and press CHANGE.

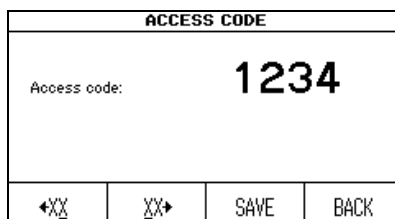

- ▶ Change the default access code to your personal code, if required. Enter the numbers by the arrow keys and select the digit with the function keys (←XX, XX→). Keep this code in a save place.

- ▶ Press SAVE.

- ▶ To activate changes switch the device off and on!

- ✓ The parameters are now protected.

6.3 Overview program definitions

- ▶ Press **SELECT PROGRAM** in the **MAIN MENU** in order to select the stored programs.

The first 4 programs of the **MEDIACLAVE 10** (STANDARD, CHOCOLATE AGAR, WATER BATH, AUTOCLAVE) and the first 3 programs of the **MEDIACLAVE 30** (STANDARD, CHOCOLATE AGAR, WATER BATH) are already pre-defined with default values.

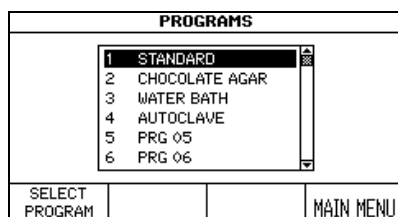

- ▶ Select a program to be defined using the arrow keys and press **SELECT PROGRAM**.
- ▶ The **PROCESS INFORMATION** window is displayed.

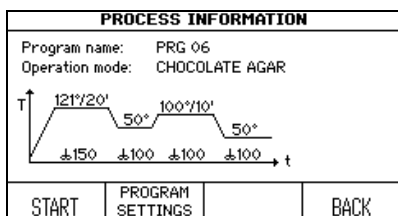

- ▶ Press **PROGRAM SETTINGS** in order to adjust the program.

	ASSISTANCE
	It is recommended to define a program name that easily identifies the operation mode, e. g. CHOCAGAR 5L. Alternatively, reserve a block of numbers for the particular operation modes.

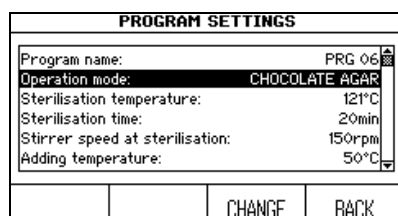

- ▶ Using the arrow keys, select a parameter you wish to change.
- ▶ Press **CHANGE**.
- ▶ Now follow the information on the screen.

There are 4 different operation modes available:

- **STANDARD**: for media preparation
- **CHOCOLATE AGAR**: for preparation of chocolate agar
- **AUTOCLAVE**: for sterilisation of media in glassware (**MEDIACLAVE 10** only)
- **WATER BATH**: for thermostating culture media in glassware using the optional autoclave cuvette (**MEDIACLAVE 10** only) or for preswelling and warming up culture media in the stainless steel cuvette (both device types).

Depending on the operation mode, parameters of different phases can be modified, e. g. heating, sterilization.

6.4 STANDARD mode

The STANDARD operation mode is used to prepare and sterilize culture media. The media is uniformly heated in the stainless steel cuvette over a water jacket, while a magnetic stirrer bar ensures homogeneous mixing.

The STANDARD process consists of the following phases: heating → sterilization → cooling → dispensing.

Heating

The heating phase brings the product temperature to the programmed sterilization temperature. To ensure sterilization, the vent valve remains open until the internally calculated value for air vent closure is reached. Hot water vapor can escape from the system allowing all non sterile air to be removed.

Sterilization

The product is maintained at the programmed target temperature for the specified duration of the sterilization phase. The maximum sterilization temperature is 122°C and the corresponding maximum pressure is approximately 1.2 bar (at 500 m AMSL). The sterilization time starts to run when the defined sterilization temperature is reached. Afterwards, the temperature is kept within the defined tolerance band.

Cooling

The cooling phase reduces the temperature to the programmed target value. External cooling water flows through the heat exchanger.

Dispensing

During the dispensing phase, the product will be thermostatted at the temperature defined and can be dispensed through the sterile dispense port.

The following table gives an overview of the parameters to be set in the STANDARD operation mode:

Program parameter	Description	Value range	Default setting
Program name	To define a program name.	16 digits	
Operation mode	STANDARD mode for preparation of media.	3 or 4 different modes	STANDARD
Sterilization temperature	Target value of the media temperature during the sterilization phase.	30-122°C	121°C
Sterilization time	Duration of the sterilization phase. The media is maintained at the programmed sterilization temperature.	0-99 min	20 min
Stirrer speed at sterilization	Speed of the magnetic stirrer during sterilization.	100-200 rpm	150 rpm
Dispensing temperature	Target value of the media temperature during the dispensing phase (maximal value not higher than sterilization temperature).	20-80°C	50°C
Stirrer speed at dispensing	Speed of the magnetic stirrer during dispensing.	50-200 rpm	100 rpm
Alternate stirrer direction	Defines whether the magnetic stirrer bar should change the stirring direction every 90 s. If OFF, the mixing performance is less efficient!	ON OFF	ON
Minimal coupling water temperature	In order to prevent gel formation, a minimum coupling water temperature can be defined (possible maximal value 3°C lower than dispensing temperature).	5-72°C	45°C

6.5 CHOCOLATE AGAR mode

The CHOCOLATE AGAR operation mode is a special two-step program that allows the preparation of complex media. After the first sterilization phase, supplements can be added through the adding port. Subsequently, the second boiling phase will be performed.

The CHOCOLATE AGAR process consists of the following phases: heating → sterilization → cooling → adding → heating → boiling → cooling → dispensing.

Adding

After heating, sterilization and cooling, the product is kept at the defined temperature to allow the addition of sensitive supplements.

Boiling

After addition of the supplement the product is brought to the programmed target temperature and is maintained at this temperature during the specified boiling time. The maximum boiling temperature is 122 °C and the corresponding maximum pressure is approximately 1.2 bar at 500 m AMSL.

For description of the other phases please refer to [“6.4 STANDARD mode” on page 39](#).

The following table gives an overview of the parameters to be set in the CHOCOLATE AGAR operation mode:

Program parameter	Description	Value range	Default setting
Program name	To define a program name.	16 digits	
Program mode	CHOCOLATE AGAR mode for preparation of complex media.	3 or 4 different modes	STANDARD
Sterilization temperature	Target value of the media temperature during the sterilization phase.	30-122 °C	121 °C
Sterilization time	Duration of the sterilization phase. The media is maintained at the programmed sterilization temperature.	0-99 min	20 min
Stirrer speed at sterilization	Speed of the magnetic stirrer bar during sterilization.	100-200 rpm	150 rpm
Adding temperature	Target value of the media temperature during the adding phase (maximal value not higher than sterilization temperature).	45-80 °C	50 °C

Program parameter	Description	Value range	Default setting
Stirrer speed at adding	Speed of the magnetic stirrer during supplement adding.	50-200 rpm	100 rpm
Boiling temperature	Target value of the media temperature during the boiling phase.	30-122 °C	100 °C
Boiling time	Duration of the boiling phase. The media is maintained at the programmed boiling temperature	0-99 min	10 min
Stirrer speed at boiling	Speed of the magnetic stirrer during boiling.	100-200 rpm	100 rpm
Dispensing temperature	Target value of the media temperature during the dispensing phase (maximal value not higher than boiling temperature).	20-80 °C	50 °C
Stirrer speed at dispensing	Speed of the magnetic stirrer during dispensing.	50-200 rpm	100 rpm
Alternate stirrer direction	Defines whether the magnetic stirrer bar should change the stirring direction every 90 s. If OFF, the mixing performance is less efficient!	ON OFF	ON
Minimal coupling water temperature	In order to prevent gel formation, a minimum coupling water temperature can be defined (possible maximal value 3 °C lower than dispensing temperature).	5-72 °C	45 °C

6.6 WATER BATH mode

The WATER BATH operation mode can be used for thermostating culture media in glassware using the optional autoclave cuvette (**MEDIACLAVE 10** only). Alternatively, it can be used for preswelling, prewarming and efficiently dissolving the culture medium in the standard cuvette prior to sterilization (both device types). The mode runs without pressure.

The WATER BATH process consists of the following phases: heating → water bath.

Heating

The heating phase brings the water bath temperature to the programmed target value.

Water bath

Keeps the bath temperature at the defined value until the program ends or is stopped.

The following table gives an overview of the parameters to be set in the WATER BATH operation mode:

Program parameter	Description	Value range	Default setting
Program name	To define a program name.	16 digits	
Operation mode	WATER BATH mode for thermostating.	3 or 4 different modes	STANDARD
Water temperature	Target value of the water temperature during the heating phase.	30-80 °C	60 °C
Time	Duration of water bath phase.	1-9 h, ∞	∞
Stirrer speed	Speed of the magnetic stirrer during water bath phase.	OFF, 50-200 rpm	0 rpm
Alternate stirrer direction	Defines whether the magnetic stirrer bar should change the stirring direction every 90 s.	ON OFF	OFF

6.7 AUTOCLAVE mode (MEDIACLAVE 10 only)

The **MEDIACLAVE 10** can be used as a bench-top autoclave to sterilise medium in containers, such as Erlenmeyer flasks or test-tubes in the AUTOCLAVE operation mode.

The AUTOCLAVE process consists of the following phases: heating → sterilization → cooling.

For description of the phases please refer to “6.4 STANDARD mode” on page 39.

The following table gives an overview of the parameters to be set in the AUTOCLAVE operation mode:

Program parameter	Description	Value range	Default setting
Program name	To define a program name.	16 digits	
Operation mode	AUTOCLAVE mode for autoclaving.	4 different modes	STANDARD
Sterilization temperature	Target value during the sterilization phase.	30-122 °C	121 °C
Sterilization time	Duration of the sterilization phase. The media is maintained at the programmed sterilization temperature.	0-99 min	20 min
End temperature	Target value of the coupling water temperature before opening (maximal value not higher than sterilization temperature).	30-70 °C	70 °C

7 Operation

Purpose This chapter describes how you can perform media preparation and sterilizing, thermostating or autoclaving.

	ASSISTANCE
	<p><i>If you are using the MEDIACLAVE for the first time, please set the system and program parameters to your requirements before starting any process (see “6.3 Overview program definitions” on page 38).</i></p> <p><i>After switching on the MEDIACLAVE, the vessel lid must be opened and closed at least once before a process can be started.</i></p>

7.1 Preparation steps before and during a process

The following preparation steps depend on the operation mode selected.

7.1.1 Cuvette

	⚠ CAUTION
	<p><i>When inserting a cuvette, make sure that the two bolts (1) properly lock into the bayonet (2). Inserting the cuvette in other positions may result in</i></p> <ul style="list-style-type: none"> • contusion of fingers between cuvette and vessel brim or • insufficient deaeration and sterilization. <p>MEDIACLAVE 30 only: The fixings for the decanting tubing and the temperature probe must be located on the very back, see “2.2.4 Cuvette interior view” on page 14.</p>

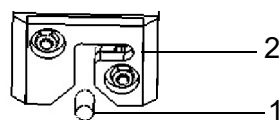

- ▶ Place the cuvette in the instrument vessel.
- ▶ Using both grips, turn the cuvette approx. 2 cm clockwise until it locks into position as shown below.

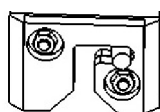

- ✓ The cuvette is ready for use.

- ▶ To remove the cuvette, turn it counter clockwise and lift it up.

	⚠ CAUTION
	<p><i>Only remove the cuvette from the MEDIACLAVE when empty. A fully filled cuvette slipping back into the vessel may result in contusion of fingers between cuvette and vessel brim or bayonet damage.</i></p>

7.1.2 Decanting tubing

- ▶ **MEDIACLAVE 30** only: insert the rigid stainless steel tube of the decanting tubing into the fixing within the cuvette.

The following instructions apply to both device types:

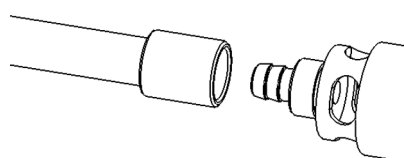

- ▶ Press the silicone decanting tubing onto the fitting nipple of the dispense port which is located on the underside of the vessel lid. (see “2.2.2 Vessel lid” on page 13).

- ▶ Attach the tubing to the fitting nipple by rotating the stainless steel securing nut clockwise until it is finger-tight.
 - ▶ **MEDIACLAVE 10** only: let the tubing directly drop down to the seam of the bottom.
- ✓ The decanting tubing is ready for use.

7.1.3 Magnetic stirrer

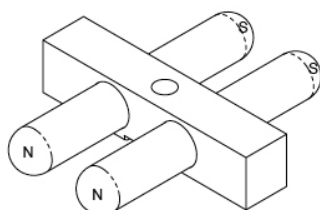



- ▶ Check if pivot pin disk is pushed fully downwards, see “8.6 Checking and replacing pivot pin disk” on page 77.
 - ▶ Place the magnetic stirrer bar on the pivot pin inside at the cuvette bottom. See “2.2.4 Cuvette interior view” on page 14.
- ✓ The stirrer is ready for use.

	⚠ CAUTION
<p><i>It is essential for medium preparation programs that the magnetic stirrer is installed and working properly. Without or with a magnetic stirrer bar not properly installed, homogeneous temperature of culture medium is not guaranteed during the sterilisation process.</i></p>	

7.1.4 Coupling water

For filling the MEDIACLAVE with coupling water please refer to “8.4.3 FILLING the vessel with coupling water” on page 73.

7.1.5 Temperature probe

	<p>NOTICE</p> <div style="display: flex; align-items: center;">  <div style="margin-left: 10px;"> <p><i>The semi-rigid temperature probe (MC 10) must be handled with great care! Be attentive not to overbend the semi-rigid body. Under all circumstances, the flexible hose MUST NOT be deflected more than 30 degrees from the vertical. Otherwise it will be permanently deformed (see picture beside).</i></p> </div> </div> <div style="display: flex; align-items: center; margin-top: 10px;">  <div style="margin-left: 10px;"> <p><i>Be attentive not to clamp the cable of the flexible temperature probe (AUTOCLAVE program and MC_30) between vessel lid and cuvette rim when closing the vessel lid. There is a high risk of damage.</i></p> </div> </div>
---	---

AUTOCLAVE mode (MEDIACLAVE 10 only)

When using the AUTOCLAVE mode, the semi-rigid temperature probe PT 1000 must be replaced by the flexible one of the autoclave kit.

- ▶ Switch off the MEDIACLAVE, unscrew and unplug the temperature probe from the interface connection at the rear side of the instrument.
- ▶ Unscrew the semi-rigid temperature probe from the vessel lid by hand. Screw the flexible temperature probe onto the lid (do not use a wrench!).

STANDARD and CHOCOLATE AGAR mode

- ▶ **MEDIACLAVE 30:** Put the guide tube into the fixing and insert the temperature probe.

The immersion depth of the temperature probe into the reference container must now be adapted, see below.

Adaption of immersion depth

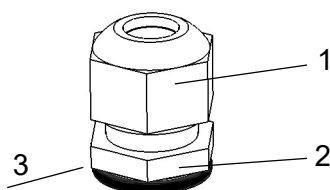

- ▶ Hold the thin screw-nut (2) of the compression fitting, which is placed on the left side of the vessel lid, with a flat wrench and open the screw-nut located above (1) counter clockwise using a flat wrench.
- ▶ Move the temperature probe into the desired position.
- ▶ For medium preparation applications, move the flexible temperature probe to the appropriate position. The length of the temperature probe from the lower edge (3) of the screw-nut (2) to the sensor tip should be approx. 259 mm for the **MEDIACLAVE 10** or approx. 702 mm **MEDIACLAVE 30** respectively. Ensure that the temperature probe is straightened before the lid is closed. The temperature probe should not contact the magnetic stirrer bar and the tip should be completely covered by media during the entire run.
- ▶ Tighten the upper screw of the compression fitting with the flat wrench such that the temperature probe can not be moved.
- ✓ The height of the temperature probe is adapted.

7.1.6 Injection lid with septum membrane

For safe adding of supplements, an optionally available injection lid with a septum membrane can be used. The supplement can be injected into the culture medium by piercing through the self-sealing septum. The septum membrane must be replaced regularly to ensure operational safety. The injection lid is mounted before starting the process.

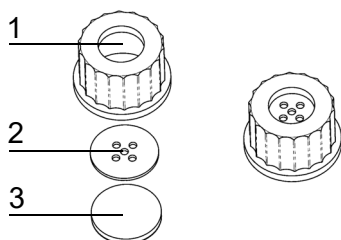

- ▶ Unscrew the adding port cap.
- ▶ Put the metallic disc (2) and the membrane (3) into the injection lid (1).
- ▶ Screw the fully assembled injection lid on the adding port.
- ✓ The injection lid is ready for use.

7.1.7 Tubing connector for adding port

For adding large volumes of supplements by means of an external pump, e. g. DOSE IT, the tubing connector can be screwed onto the adding port at the beginning of the adding or dispensing phase.

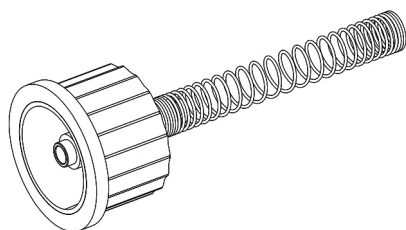

- ▶ Unscrew the adding port cap.
- ▶ Screw the tubing connector onto the adding port.
- ▶ Connect the tubing of the external pump to the connector. Use a silicone tubing with an inner diameter of 6 mm and an outer diameter of 9 mm.
- ▶ Stabilize the tubing with the stainless spring.
- ✓ The supplement can be added by an external pump.

7.1.8 Pressure dispensing kit

This optionally available kit, including pinch valve box, foot switch, silicone tubing and stainless steel dispensing tube is used for dispensing the product automatically by the MEDIACLAVE compressor. The pressure dispense kit is installed in the dispensing phase.

- ▶ Connect the external pinch valve box and the foot switch to the corresponding interfaces on the rear side (see [“2.2.5 Rear panel”](#) on page 15).

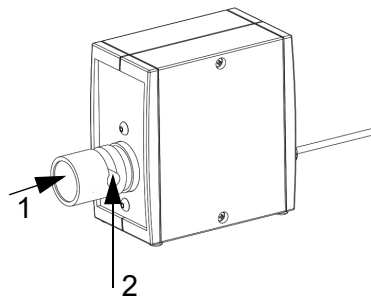

- ▶ Unscrew the dispense port cap. Insert the tubing with the sterile fitting for dispensing tubing and secure it with the securing nut.
- ▶ Use the cut outs of the safety cover to guide the tubing without bends to the desired side.
- ▶ Press the button of the pinch valve (1) and place the tubing into the notch (2).

- ✓ The pressure dispense kit is ready for use.

7.2 Run the STANDARD or CHOCOLATE AGAR program

Prior to each process, the cuvette, temperature probe, decanting tubing and the magnetic stirrer bar must be installed and the vessel filled with coupling water (see “8.4.3 FILLING the vessel with coupling water” on page 73). Add the desired amount of liquid and culture medium formulation to the cuvette.

	NOTICE
	<p><i>The nominal volume of cuvettes (10 / 30L) must not be exceeded. Consider vortex, foam or bubble formation and swelling. Overfilling may result in severe contamination and system damage.</i></p>

Before each new run, check if the upper coupling water level sensor is covered and refill coupling water, if necessary.

- ▶ Press SELECT PROGRAMS in the **MAIN MENU** in order to navigate to the stored programs.

MAIN MENU			
INTEGRA		Temperature 21.8°C	
29.March 2010	10:42:45	Pressure 0.00bar	
SELECT PROGRAM	MAIN-TENANCE	SYSTEM PARAMETER	

- ▶ In the **PROGRAMS** window select the previously defined STANDARD or CHOCOLATE AGAR program using the arrow keys.

- ▶ Press SELECT PROGRAM.

- ✓ The magnetic stirrer starts rotation.

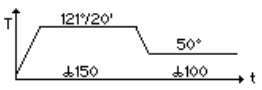
PROCESS INFORMATION			
Program name: PRG 05		Operation mode: STANDARD	
			
START	PROGRAM SETTINGS		BACK



The **PROCESS INFORMATION** window displays all program phases.

- ▶ Press START and follow the instructions on the screen.

PREPARE FOR PROCESS			
<ul style="list-style-type: none"> ▶ Insert cuvette ▶ Check coupling water ▶ Close vessel lid ▶ Close adding and dispense port ▶ Close safety cover ▶ Press '▲' and '▼' keys to set delay: 0min 			
START	ENTER LOT NO.	ENTER USER	ABORT

- ▶ Unscrew the adding port cap such that air can escape the sterilization chamber when closing the vessel lid, thereby preventing overpressure and increased friction of the bayonet catch.

- ▶ If desired, a start delay can be set between 0-24 hours by pressing the arrow keys.

	NOTICE	
		<p><i>The semi-rigid temperature probe (MC 10) must be handled with great care! Be attentive not to overbend the semi-rigid body. Under all circumstances, the flexible hose MUST NOT be deflected more than 30 degrees from the vertical. Otherwise it will be permanently deformed (see picture beside).</i></p>
	<p><i>Be attentive not to clamp the cable of the flexible temperature probe (MC_30) between vessel lid and cuvette rim when closing the vessel lid. There is a high risk of damage.</i></p>	

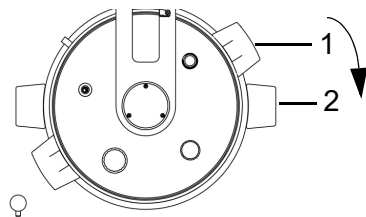

- ▶ Close the vessel lid by turning the grips clockwise around the attachment point. The grips of the vessel lid (1) must be aligned above the black stickers (2).

- ▶ After closing the vessel lid ensure that all port caps are screwed finger-tight.

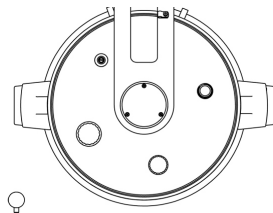

- ▶ If the vessel lid is not aligned as shown in the picture beside, the safety of the instrument is severely compromised.

- ▶ Close the safety cover.

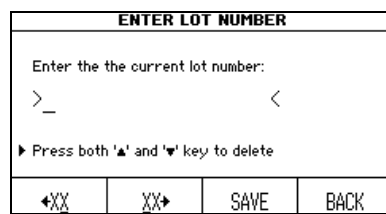

- ▶ If desired, select ENTER LOT NO.
- ▶ Enter the batch number with the XX keys and press SAVE.

- ▶ If desired, press ENTER USER, enter the user name by pressing the arrow keys and press SAVE.

- ▶ Press START.

✓ The MEDIACLAVE starts system check and tightness test.

The safety cover is locked automatically during program operation by a bolt, protecting the user against burns.

The MEDIACLAVE initializes all instrument functions and corresponding sensors. It verifies whether sufficient coupling water is added and the vessel lid and the safety cover are closed.

	ASSISTANCE
	<p><i>If an alerting error message appears, follow all on-screen instructions.</i></p> <p>If tightness test fails, ensure that all caps are closed. In case of repeated failure, remove the lid seal, wet it well and insert it again.</p>

When the tightness test is successfully completed, a black progress bar within the time/temperature curve shows the progress of the program:

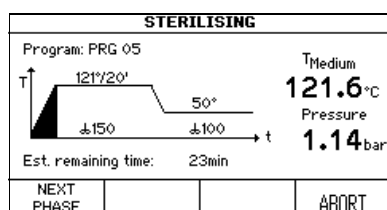

- ▶ A phase can be shortened by pressing NEXT PHASE (not during the heating phase and during the cooling phase) or aborted at any time, if required, by pressing ABORT twice.

	⚠ DANGER
<p><i>In error case the instrument must not be used, e. g. if</i></p> <ul style="list-style-type: none"> • the pressure value is not displayed, • the pressure value displayed is above 1.7. bar or • hot steam is released from the safety valve at the top of the vessel lid. <p><i>There is the risk of burns or explosion. The instrument must be immediately switched off and separated from electricity supply. Stay away from the device.</i></p>	

7.2.1 Adding (CHOCOLATE AGAR mode only)

For adding supplements you can use the optionally available injection lid. If using this option, exchange the adding port cap by the injection lid before beginning of the process, see “7.1.6 Injection lid with septum membrane” on page 48. For adding larger volumes of supplements by means of an external pump, install the tubing connector for adding port at the beginning of the adding phase, see “7.1.7 Tubing connector for adding port” on page 48.

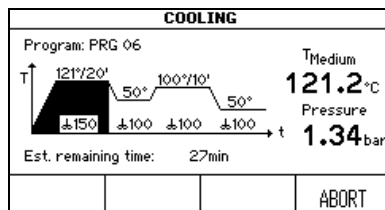

After the first sterilisation phase, the product is cooled down to allow the addition of sensitive supplements. When the adding temperature is reached, you are prompted by an acoustic sound.

- ▶ Switch off the acoustic sound by pressing the  sign.

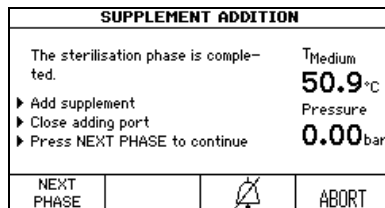

- ▶ Open the safety cover and the adding port cap. Add the supplements to the medium.
- ▶ Press NEXT PHASE.
- ✓ The MEDIACLAVE starts heating.

7.2.2 Dispensing the product

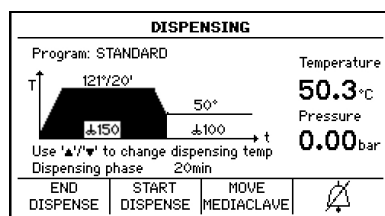

- ▶ When the dispensing phase is reached, the operator is informed by an acoustic sound (switch off by pressing ).
- ▶ To change the dispensing temperature, use the arrow keys.

- ▶ Press START DISPENSE. The product can now be dispensed through the sterile dispensing port.



ASSISTANCE

MEDIACLAVE can be moved to another location for dispensing. Press MOVE MEDIACLAVE and follow on-screen instructions. There is no water connection needed to keep the temperature during the dispensing phase.

- ▶ Select the dispensing type, i.e. standard or pressure dispense.
- ▶ Pressing END DISPENSE twice finishes the program immediately.

Standard dispense

For dispensing, the MEDIACLAVE can be connected to an external pump, e. g. DOSE IT or MEDIAJET. In this case, press STANDARD DISPENSE and consider the operating instructions of these instruments.

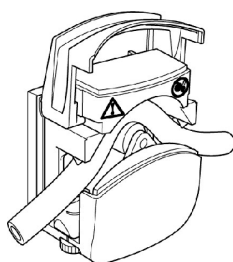

- ▶ Unscrew the dispense port cap (see [“2.2 Overview of MEDIACLAVE”](#) on page 13), insert the sterile fitting for dispensing tubing and secure it with the securing nut.
 - ▶ Insert one end of a silicone tubing (inner diameter of 6 mm, outer diameter of 9 mm) into the stainless spring and push it onto the fitting.
- ▶ Connect the tubing to the external pump.
 - ✓ The dispensing is controlled by the external instrument.

After dispensing press BACK and press twice END DISPENSE to finish the process.

Pressure dispense

Alternatively, press PRESSURE DISPENSE for dispensing the product automatically by the MEDIACLAVE compressor.

PRESSURE DISPENSE	
▶ Connect the pinch valve, the tubing and optionally the foot switch	Temperature 50.3 °C
▶ Set flow rate (keys ▲ and ▼)	Pressure 0.00 bar
▶ Close safety cover	
Flow rate: Level 1	
DISPENSE	BACK

- ▶ Connect the external pinch valve box and optionally the foot switch to the corresponding interfaces on the rear side.
- ▶ Unscrew the dispense port cap (see “2.2 Overview of MEDIACLAVE” on page 13). Insert the tubing with the sterile fitting for dispensing tubing and secure it with the securing nut.

- ▶ Insert one end of a silicone tubing with an inner diameter of 6 mm and an outer diameter of 9 mm into the stainless spring and push it onto the fitting.
- ▶ Place the tubing in the pinch valve, see “7.1.8 Pressure dispensing kit” on page 49. Use the cut outs of the safety cover to guide the tubing without bends to the desired side.
- ▶ Close the safety cover.
- ▶ Enter a flow rate from level 1 (0.1 bar, ~1.6 l/min¹) to 10 (1.0 bar, ~6.0 l/min¹) in steps of 0.1 bar using the arrow keys.

	WARNING
	<i>In case of malfunction of the temperature probe, there is the risk of burns due to hot media. Always wear oven gloves when touching the tubing.</i>

- ▶ The medium is dispensed as long as the DISPENSE key or the foot switch are pressed. Start dispensing and check the flow rate.
- ▶ When the cuvette is empty, press BACK and END DISPENSE and wait for depressurization.

7.2.3 Opening the MEDIACLAVE

- ▶ Using both grips, turn the vessel lid counter clockwise until it unlocks and opens.

	ASSISTANCE
	If you can not open the vessel lid easily, slightly unscrew the adding port cap to release any residual pressure (this weak overpressure may be generated by natural evaporation).

- ▶ Switch off the MEDIACLAVE and perform a daily maintenance procedure, see “8.2 Daily maintenance” on page 69.
- ✓ The MEDIACLAVE is ready for a new run.

1. for water and 6 mm ID tubing, depends on viscosity and tubing.

7.3 Run the WATER BATH program

When using the WATER BATH mode, the vessel lid must be left open. The safety cover remains open.

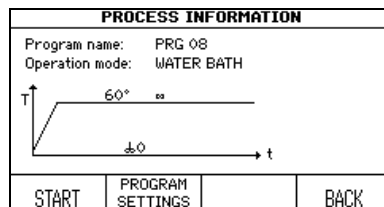

- ▶ In the **PROGRAMS** window select the previously defined WATER BATH program and press SELECT PROGRAM.
- ▶ The **PROCESS INFORMATION** window opens. Press START.



⚠ CAUTION

In order to avoid scalding from hot splashes, always install a cuvette.

Thermostating of media in glassware (MEDIACLAVE 10 only)

- ▶ Install the autoclave cuvette (see [“7.1.1 Cuvette”](#) on page 45) together with the stainless steel grid insert.
- ▶ Put the laboratory containers, flasks or test tubes into the autoclave cuvette.
- ▶ Fill in approx. 2.5 l of coupling water such that the water level is slightly under the medium surface inside the glass container.

Formulation of culture media (prewarming and preswelling)

- ▶ Install the cuvette and add culture media.
- ▶ Press START.
- ✓ The MEDIACLAVE starts system check.

The progress of the program is shown in the time/temperature curve.

7.3.1 End of WATER BATH program

- ▶ Press END to terminate the thermostating phase.
- ✓ Wait until the water is cooled down.

7.4 Run the AUTOCLAVE program (MEDIACLAVE 10 only)

	NOTICE
	<p><i>When using the AUTOCLAVE mode, the autoclave cuvette and the flexible temperature probe must be installed (see “7.1 Preparation steps before and during a process” on page 45).</i></p>

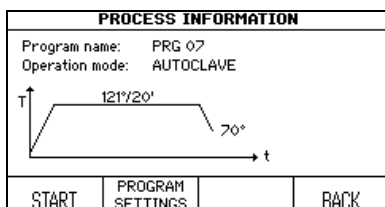

- ▶ In the **PROGRAMS** window select the previously defined AUTOCLAVE program and press SELECT PROGRAM.
- ▶ The **PROCESS INFORMATION** window opens. Press START.

- ▶ Fill the vessel with coupling water to a minimal height of 2 cm above the cuvette bottom (3.9 l).
- ▶ Insert the laboratory containers, flasks or test tubings into the cuvette and ensure that they are distributed evenly.

	⚠ DANGER
	<p><i>The MEDIACLAVE is not suitable for sterilization of instruments, glassware and medical devices, as it does not perform vacuum cycles preventing air pockets inside the instrument. Therefore, sterilization is not given. All containers must be opened throughout the whole process. Otherwise, they can get broken.</i></p>

- ▶ When autoclaving liquids, put the flexible temperature probe into a reference container with the same size and amount of liquid as the others. Adapt the length of the temperature probe, if necessary, see 7.1.5. The coupling water must be slightly under the medium surface inside the glass container to ensure an optimal heat transfer. Too little coupling water may increase the cooling time remarkably (poor heat transfer from medium in containers to coupling water).
- ▶ Unscrew the adding port cap such that air can escape the sterilization chamber when closing the vessel lid, thereby preventing overpressure and increased friction of the bayonet catch.

	NOTICE
	<p><i>The flexible temperature probe must be handled with great care! Be attentive not to clamp the cable between vessel lid and cuvette rim when closing the vessel lid. There is a high risk of damage.</i></p>

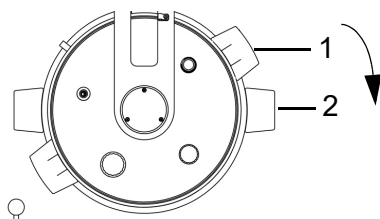

- ▶ Close the vessel lid by turning the grips clockwise around the attachment point. The grips of the vessel lid (1) must be aligned above the black stickers (2).

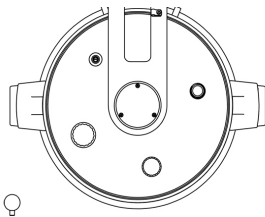

- ▶ If the vessel lid is not aligned as shown in the picture beside, the safety of the instrument is severely compromised.

- ▶ After closing the vessel lid ensure that all port caps are screwed finger-tight.
- ▶ Close the safety cover.
- ▶ Press START.
- ✓ The MEDIACLAVE starts system check and tightness test.

The safety cover is locked automatically during program operation by a bolt, protecting the user against burns.

	ASSISTANCE
	<i>If an alerting error message appears, follow all on-screen instructions. If tightness test fails, ensure that all caps are closed. In case of repeated failure, remove the lid seal, wet it well and insert it again.</i>

The progress of the program is shown in the time/temperature curve.

	⚠ DANGER
	<i>In error case the instrument must not be used, e. g. if</i> <ul style="list-style-type: none"> • the pressure value is not displayed, • the pressure value displayed is above 1.7. bar or • hot steam is released from the safety valve at the top of the vessel lid. <i>There is the risk of burns or explosion. The instrument must be immediately switched off and separated from electricity supply. Stay away from the device.</i>

- ▶ A phase can be shortened by pressing NEXT PHASE (not during the heating phase and during the cooling phase) or aborted at any time by pressing ABORT twice.

	ASSISTANCE
	The safety cover can not be opened as long as the instrument is under pressure.

7.4.1 End of AUTOCLAVE program

- ▶ Once the AUTOCLAVE phase is finished press END to open the safety cover.
- ▶ Using both grips, turn the vessel lid counter clockwise until it unlocks and opens.
- ▶ Remove the autoclaved material from the vessel.

	ASSISTANCE
	If you can not open the vessel lid easily, slightly unscrew the adding port cap to release any residual pressure (this weak overpressure may be generated by natural evaporation).

7.5 Error handling

7.5.1 Error notifications

	⚠ DANGER
<p><i>Disregarding the instructions on the display may have serious consequences, such as damage to the equipment, damage to property or injury to personnel!</i></p> <p>Please note, that error notifications require special caution. Water and medium within the vessel may still be very hot and the vessel still under pressure. Therefore, caution is required when opening ports or the vessel lid (potential risk of delay in boiling). Always wear safety goggles and oven gloves!</p>	

In the event of an error an acoustic alarm sounds.

- ▶ Switch off the active alarm tone by pressing the  sign.
- ▶ Read the alarm text on the display and follow the instructions.
- ✓ When the error has been removed you can continue working.

	ASSISTANCE
<p><i>There are various error codes for quick and easy error diagnosis. In case a TECHNICAL ERROR is displayed, please save the log files to a USB flash drive (see “6.2.5 Saving all log files to USB flash drive” on page 36) and contact the local customer service department.</i></p>	

7.5.2 Error messages during operation

The following errors will prevent the start or will cause the abort of the operation, respectively.

No.	Error message	Technical cause	Possible cause and correction
E1	Over temperature medium	The measured temperature of the media is above the allowed range.	Dysfunction of temperature probe. <ul style="list-style-type: none"> ▶ Check the temperature probe for damages. ▶ Check the temperature probe contact plug for dirt. ▶ Call service technician.

No.	Error message	Technical cause	Possible cause and correction
E2	Failure temperature medium	Failure of temperature probe detected.	Temperature sensor is not inserted. <ul style="list-style-type: none"> ▶ Insert temperature probe. ▶ Check temperature probe contact plug visually. Dysfunction of temperature probe. <ul style="list-style-type: none"> ▶ Check the temperature probe for damages. ▶ Check the temperature probe contact plug for dirt. ▶ Call service technician.
E3	Over temperature coupling water	The measured temperature of the coupling water is above the allowed range.	Malfunction of coupling water circulation. <ul style="list-style-type: none"> ▶ Check water strainer at the bottom of the vessel for dirt and clean it, if necessary. ▶ Check water circulation in water bath mode. Malfunction of coupling water level sensors. <ul style="list-style-type: none"> ▶ Call service technician. Malfunction of heating control. <ul style="list-style-type: none"> ▶ Call service technician.
E4	Failure temperature sensor coupling water	Failure of temperature sensor for coupling water detected.	Malfunction of coupling water level sensors. <ul style="list-style-type: none"> ▶ Call service technician.
E5	Over temperature heater	The measured temperature of the heater is above the allowed range.	Malfunction of coupling water circulation. <ul style="list-style-type: none"> ▶ Check water strainer at the bottom of the vessel for dirt and clean it, if necessary. ▶ Perform a FILLING procedure in the MAINTENANCE menu, remove the cuvette to visually inspect, if the coupling water is circulated by the circulation pump. Malfunction of sensor. <ul style="list-style-type: none"> ▶ Call service technician. Malfunction of heating control. <ul style="list-style-type: none"> ▶ Call service technician.

No.	Error message	Technical cause	Possible cause and correction
E6	Failure temperature sensor heater	Failure of heater temperature sensor detected.	Malfunction of sensor. ▶ Call service technician.
E7	Cooling process interrupted	Power failure or power off.	Power failure. ▶ Wait until cooling process completed. ▶ Call service technician. Switching off unit on intention. ▶ Wait until cooling process completed. ▶ Call service technician.
E8	Pressure too high! Leave vessel lid open during water bath	Vessel lid closed.	Vessel lid closed. ▶ Leave vessel lid open.
E9	Over pressure	The measured pressure is above the allowed range.	Malfunction of heating control. ▶ Call service technician. Malfunction of sensor. ▶ Call service technician.
E10	Level coupling water too low	The level of the coupling water is too low. The conductivity of the coupling water is too low.	Not enough coupling water. ▶ Clean the sensor with dry cloth. ▶ Refill coupling water (the upper coupling water level sensor must be covered with cuvette inserted). High-viscosity medium. Coupling water is evaporated due to slow heat transfer. ▶ Use stirrer bar with paddle and increase stirrer speed. ▶ Pre-warm medium to 80 °C using the water bath mode. Malfunction of sensor. ▶ Call service technician. Water level is OK (upper coupling water level sensor is covered with cuvette inserted). ▶ Add tap water or salt, see <u>8.4.3.</u>

No.	Error message	Technical cause	Possible cause and correction
E11	Safety cover opened	Sensor detected open safety cover.	<p>Safety cover opened.</p> <ul style="list-style-type: none"> ▶ Close the safety cover. <p>Missing safety cover magnet.</p> <ul style="list-style-type: none"> ▶ Check the magnet visually. <p>Safety cover too strongly deformed; magnet is not detected by the sensor.</p> <ul style="list-style-type: none"> ▶ Call service technician. <p>Malfunction of safety cover lock.</p> <ul style="list-style-type: none"> ▶ Call service technician. <p>Malfunction of sensor.</p> <ul style="list-style-type: none"> ▶ Call service technician.
E12	Vessel lid open	Sensor detected open vessel lid.	<p>Vessel lid opened.</p> <ul style="list-style-type: none"> ▶ Close the vessel lid. <p>Missing vessel lid magnet.</p> <ul style="list-style-type: none"> ▶ Check the magnet visually, located underside of vessel lid grips. <p>Malfunction of the lid bajonet lock.</p> <ul style="list-style-type: none"> ▶ Call service technician. <p>Malfunction of sensor.</p> <ul style="list-style-type: none"> ▶ Call service technician.
E13	Timeout during heating phase	Duration of heating phase is too long.	<p>Cooling valve permanently opened.</p> <ul style="list-style-type: none"> ▶ Call service technician. <p>Failure of heater.</p> <ul style="list-style-type: none"> ▶ Call service technician.

No.	Error message	Technical cause	Possible cause and correction
E15	Temperature difference medium to coupling water too high	Temperature difference between medium and coupling water is above the allowed range.	Malfunction of coupling water circulation. <ul style="list-style-type: none"> ▶ Check if the magnetic stirrer is placed inside the cuvette ▶ Refill coupling water (the higher water sensor must be covered). ▶ Check water strainer at the bottom of the vessel for dirt and clean it, if necessary. ▶ In WATER BATH mode, remove the cuvette to visually inspect, if the coupling water is circulated by the circulation pump. Malfunction of temperature probe or circulation pump defective. <ul style="list-style-type: none"> ▶ Call service technician.
E17	Error circulation pump	Blocked or defective pump.	Pump clogged by polluted coupling water. <ul style="list-style-type: none"> ▶ Call service technician.
E18	Pressure drop during process	Excessive pressure lost during process.	Gasket sealing not sufficient. <ul style="list-style-type: none"> ▶ Check the caps of the adding and dispense port. ▶ Check the lid seal. Malfunction of sensor. <ul style="list-style-type: none"> ▶ Call service technician.
-	Warning safety valve	Safety valve test is due!	<ul style="list-style-type: none"> ▶ Check the safety valve, see 8.5.
-	Mainboard overheated during the process	Main board temperature too high.	Ambient temperature too high. <ul style="list-style-type: none"> ▶ Meet preconditions of operating environment, see 3.1.1. Insufficient, reduced cooling. <ul style="list-style-type: none"> ▶ Check fan at rear panel, see 2.2.5. ▶ Call service technician.

7.5.3 Tightness test

During the start of a process the tightness test checks whether the system is tight. If not, an alerting error message appears on the screen.

Error message	Technical cause	Possible cause and correction
Tightness test fails	Lid seal not tight.	▶ Check lid seal, wet or replace it, if necessary.
	Cap of adding or dispense port not tight.	▶ Close caps firmly.
	Back pressure in the water outlet hose.	▶ Ensure that the water outlet hose is not blocked and correctly installed according to 3.3.2.
	Back pressure in the deaeration hose.	▶ Ensure that the deaeration hose is not blocked and correctly installed according to 3.3.2.
	Leaking internal tubing.	▶ Call service technician.
	Sterile filter blocked.	▶ Call service technician.
	Compression fitting of the temperature probe not tight.	▶ Tighten the screw of the compression fitting, see 7.1.5
	Leaking Temperature probe for medium	▶ Check temperature probe inside the vessel: <ul style="list-style-type: none"> • Semi-rigid: overbended T-probe. Call service technician. • Flexible: jammed cable. Call service technician.

7.5.4 System messages

System messages about the status of the device are displayed in the main menu and stored in SYSTEM PARAMETER - SYSTEM MESSAGES, where they can be re-displayed and deleted.

Error message	Technical cause	Possible cause and correction
Button jammed	Jammed soft key detected.	Keypad or electronic defect. ▶ In case of recurrence or dysfunction call service technician.
Data loss in program memory	Data loss in the program memory and settings detected.	Battery of the program memory is empty. ▶ Check programs before run. ▶ Call service technician.
Software error	Not expected status of the software detected.	▶ Inform service technician during next visit.
Error serial interface "Protocol printer"	Transmission error of the serial interface.	Communication erroneous. ▶ Check external printer settings (set to 9600 baud, no parity, 1 stop bit, XON XOFF). ▶ Check cable and plug of the instrument. ▶ Call service technician.
Error serial interface "Mediajet"	Transmission error of the serial interface.	Communication erroneous. ▶ Check cable and plug of the instrument. ▶ Call service technician.
Overflow printer memory	Too many digits in the printer memory.	Printer defect or printer settings erroneous. ▶ Call service technician.
Device service due	Device 1 year or 1000 sterilization cycles in operation since last service	▶ Organize mandatory service.
Ethernet connection failed	Unexpected ethernet protocol error	▶ Upon completion of the run restart the device (main switch off/on). ▶ In case of frequent reoccurrence call service technician.
Over-temperature heater, call service technician	Calcified heater	▶ Call service technician for decalcifying.

Error message	Technical cause	Possible cause and correction
Connect USB drive or disable USB documentation	USB flash drive not connected	▶ Connect USB flash drive or disable USB documentation.
Error USB flash drive	USB flash drive error or drive full	▶ Replace or format drive.
Error USB port / drive	Defective USB port or flash drive	▶ Call service technician.

7.5.5 Problems during operation

The following table can help to solve certain problems that may be encountered when operating MEDIACLAVE.

Symptom	Possible Cause	Corrective Action
Insufficient or no pressure buildup during the cooling phase	<ul style="list-style-type: none"> • Sterile filter is blocked or wet • Malfunction of compressor 	▶ Call service technician.
Safety cover does not open at the end of a run	<ul style="list-style-type: none"> • The temperature of the medium is above the allowed range (max. 80 °C) • Critical error recognized. Temperature or pressure too high. • Venting valve blocked 	▶ Allow the instrument and media to cool to below 80°C. A cooling phase may need to be started. ▶ Wait until safety cooling phase is finished (max. 3 h). Potentially excess pressure will be relieved down. ▶ Call service technician.
Instrument does not start up	<ul style="list-style-type: none"> • Plug is not connected to the electricity supply • Supply voltage failure • Fuse has blown in main switch or electronics 	▶ Check connection to power. ▶ Call service technician.
The instrument does not work properly after starting a program	<ul style="list-style-type: none"> • Settings are incorrect • Safety cover is open • Vessel lid is open • Dispensing or adding cap is not sufficiently tight 	▶ Check all settings. ▶ Close vessel lid. ▶ Close safety cover. ▶ Manually tighten all caps.

Symptom	Possible Cause	Corrective Action
Mains power cut	<ul style="list-style-type: none"> • Power failure • Plug is not connected to the electricity supply • Fuse acted 	<ul style="list-style-type: none"> ▶ Check electricity supply and plug connection to power. ▶ For restart after power failure switch the instrument off. Insert plug and switch the instrument on. You are prompted whether you want to continue the process. ▶ Call service technician to press the fuse switch.
Too slow heating up	<ul style="list-style-type: none"> • Deaeration hoses blocked or misconnected • Caged deaeration valve • Operation environment above the limit of 2000 m • Failure of heater 	<ul style="list-style-type: none"> ▶ Check deaeration hoses, see 3.3.2. ▶ Call service technician.
Too slow cooling down	<ul style="list-style-type: none"> • Failure of cooling water flow 	<ul style="list-style-type: none"> ▶ Open the water tap and check the cooling water hoses. ▶ Check pressure of cooling water, see 3.3.1. ▶ Call service technician to adjust water flow.
Temperature sensor displays strange value	<ul style="list-style-type: none"> • 999.9 °C: Temperature probe or sensor not connected • 0.0 °C: Temperature probe or sensor damaged 	<ul style="list-style-type: none"> ▶ Check that the temperature probe is plugged into the socket on the back of the device. ▶ Call service technician.

8 Maintenance

Purpose This chapter describes the regularly required maintenance procedures and the disposal of the MEDIACLAVE.

	⚠ DANGER
The MEDIACLAVE requires periodical cleaning in order to ensure safe and reliable operation.	

8.1 Overview

	NOTICE
Only use the cleaning or decontamination methods recommended by the manufacturer, otherwise the instrument may be damaged.	

8.1.1 Service and maintenance intervals

The following service and maintenance intervals are mandatory:

- **Installation** - is carried out by a qualified service technician.
- **Daily** - manual cleaning by the user at least at the end of a working day, see “8.2 Daily maintenance” on page 69.
- **Monthly** - automatic steam sterilization with the CLEANING procedure, manual cleaning and function checks (safety valve, pivot pin) carried out by the user, see “8.3 Monthly CLEANING” on page 70.
- **Yearly or after 1000 sterilization cycles** (whatever is reached first) - service carried out by authorized personnel.
- **End of life span** - after 10'000 sterilization cycles.

	ASSISTANCE
After one year in operation since the last service or after 1000 sterilization cycles, a service reminder is displayed in the MAIN MENU. To look up when the service is due, open the service reminder under SYSTEM PARAMETER - INFO.	

8.1.2 MAINTENANCE functions

MAINTENANCE			
▶ Press CLEANING for cleaning and sterilisation of internal hydraulics			
▶ Press DRAINING / FILLING for draining or filling functions			
▶ Press SAFETY VALVE to test the functioning of the safety valve.			
CLEANING	DRAINING / FILLING	SAFETY VALVE	MAIN MENU

▶ Press **MAINTENANCE** in the **MAIN MENU**.

Three procedures are accessible by the function keys:

- **CLEANING:** Automatically sterilizes the vessel, valves and tubing inside the MEDIACLAVE. Hot, sterile coupling water is drained at the process end, dissolving and removing unwanted agar residues in the system effectively.
- **DRAINING / FILLING:**
 - To drain the coupling water automatically from the vessel,
 - to drain the cuvette or
 - to fill the vessel of the MEDIACLAVE with coupling water.
- **SAFETY VALVE:** To perform a functional test of the safety valve.



8.1.3 Materials required

- Washing detergent: mix one part of low foaming liquid dish washer with three parts of water
 - Soft, lint-free cleaning cloth
 - Chrome steel cleaning agent
 - Soft, non abrasive scrub sponge
- Paper towels

	NOTICE
	Never use disinfectant containing acetone or hypochlorite (ClO ⁻ , e.g. bleach; CAS-Nr. 7681-42-9).

8.2 Daily maintenance



Carry out the following manual cleaning after every STANDARD or CHOCOLATE AGAR run or at least at the end of a working day.



	 WARNING
	Before starting manual cleaning, ensure the MEDIACLAVE is switched off and disconnected from the electricity supply.

Clean the instrument parts listed below with a lint free cleaning cloth and washing detergent.

	NOTICE
	Do not use cleaning or disinfection agents containing sulfur, chlorine, fluorine or bromine on MEDIACLAVE. Such agents may promote stress corrosion cracking. Be careful not to spill any nutrient media or additives into the water jacket between vessel and cuvette. In case of spillover immediately exchange the entire coupling medium. Salt contents above 1% in nutrient media or broths should also be avoided in order to prolong service life. Vessel cracks are most likely to start from the circumference of the vessel side bayonet section. Please consult INTEGRA or its local representative immediately if any such cracks become visible before continuing to use MEDIACLAVE.

- ▶ Unscrew the dispensing tubing from the dispense port and clean it.
- ▶ Open the vessel lid. Disconnect and clean the decanting tubing.
- ▶ Remove the cuvette. Be cautious not to damage the temperature probe. Clean the cuvette, the cuvette grips with bayonet and the pivot pin which holds the magnetic stirrer bar, see [“7.1.1 Cuvette” on page 45](#).
- ▶ Clean the temperature probe and the magnetic stirrer bar.
- ▶ Clean the vessel including the coupling water level sensors (remove invisible biofilm), the deaeration and support pressure opening and the drain with the water strainer.
- ▶ Clean the vessel lid and the dispense and adding ports. Screw the clean caps again. Clean the lid seal and insert it again.

	NOTICE
	<div style="display: flex; align-items: center;">  <div style="margin-left: 10px;"> <p>The semi-rigid temperature probe (MC 10) must be handled with great care! Be attentive not to overbend the semi-rigid body. Under all circumstances, the flexible hose MUST NOT be deflected more than 30 degrees from the vertical. Otherwise it will be permanently deformed.</p> </div> </div>

	 CAUTION
	Do not clean the safety cover with organic solvent, e. g. Acetone. Use washing detergent instead. Do not let the solution drip inside the MEDIACLAVE.

- ▶ At the end of a working day, visually check the instrument for obvious spills and clean the housing with a cleaning cloth.
- ▶ If you use media with salt concentrations above 3%, causing corrossions of stainless steel, rinse all salt residues thoroughly with plenty of water. Apply a stainless steel cleaning agent to all affected surfaces according to the instructions by the manufacturer (e. g. 10 minutes). Completely remove it with warm water and a sponge.
- ▶ Dry all areas with paper towels.
- ▶ As an aid, the maintenance qualification form can be used, see “11.2 Maintenance qualification form” on page 94.
- ✓ The MEDIACLAVE is now cleaned.

8.3 Monthly CLEANING

	⚠ CAUTION
<p>It is mandatory to perform a steam sterilization by using the automatic CLEANING procedure every month, after 20 program runs or if the coupling water is visibly dirty. Less frequent coupling water exchanges can cause damages.</p> <p>After 10 runs without exchanging the coupling water, an alerting message will be displayed before every run.</p>	

- ▶ Open the **MAINTENANCE** window.

MAINTENANCE			
<ul style="list-style-type: none"> ▶ Press CLEANING for cleaning and sterilisation of internal hydraulics ▶ Press DRAINING / FILLING for the drain an the fill function, respectively. ▶ Press SAFETY VALVE to test the functioning of the safety valve. 			
CLEANING	DRAINING / FILLING	SAFETY VALVE	MAIN MENU

- ▶ Press CLEANING for the automatic system sterilisation and hot draining of the vessel.

CLEANING PROCESS			
<ul style="list-style-type: none"> ▶ Insert cuvette with 1l/3l water ▶ Add coupling water ▶ Close vessel lid ▶ Close adding and dispense port ▶ Close safety cover 			
START			BACK

- ▶ Follow the instructions on the screen (see also “7.1 Preparation steps before and during a process” on page 45).
- ▶ 1 L water for MC 10, 3 L for MC 30.
- ▶ Close the vessel lid and the safety cover.
- ▶ Press START.

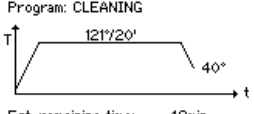
HEATING							
Program: CLEANING 		Temperature 19.9°C	Pressure 0.00bar				
Est. remaining time: 48min		<table style="width: 100%; border: none;"> <tr> <td style="border: none;"></td> <td style="border: none;"></td> <td style="border: none;"></td> <td style="border: none; text-align: center;">ABORT</td> </tr> </table>					ABORT
			ABORT				

A black progress bar in the time/temperature curve shows the progress of the program. The approximate duration is 45 min.

At the end of the program the coupling water is pumped out of the vessel.

- ▶ Press MAIN MENU when the **PROCESS COMPLETED** window is displayed.
- ✓ The internal counter for coupling water exchange is reset to zero.

Proceed now with manual cleaning and function checks:

- ▶ Switch off the MEDIACLAVE and disconnect it from the electricity supply.
- ▶ Clean the instrument parts mentioned under daily maintenance (see “8.2 Daily maintenance” on page 69) with a cleaning cloth and washing detergent.
- ▶ Check the opening of the safety valve on the underside of the vessel lid. If it is soiled, clean it, splash hot water with a syringe into the safety valve.
- ▶ Visually check the cuvette and the vessel for encrusted dirt and brown spots. Apply a stainless steel cleaning agent to all affected surfaces according to the instructions by the manufacturer (e. g. 10 minutes). Completely remove it with warm water and a sponge.

	⚠ CAUTION
	Failure to completely remove the chrome steel cleaning agent will result in instrument corrosion.

- ▶ Dry all areas with a paper towel.
- ▶ Change the vessel lid seal if it is damaged or at least after every 100 runs.
- ▶ Check whether a red strip on the printer paper roll indicates that the roll is nearly empty and replace it, if required, see “8.6 Checking and replacing pivot pin disk” on page 77.
- ▶ Switch on the MEDIACLAVE and let it execute a self test during initialization.
- ▶ Check the function of the safety valve, see “8.5 Checking the safety valve” on page 75.
- ▶ Check the magnetic stirrer for wear and tear. The rims should not touch the bottom of the cuvette. Paddles can be removed with a screw driver.
- ▶ Initial the appropriate boxes upon completion of monthly maintenance, see “11.2 Maintenance qualification form” on page 94
- ✓ The monthly maintenance is now completed.

8.4 DRAINING / FILLING procedure

- ▶ To access the draining/filling procedures press MAINTENANCE in the **MAIN MENU** and select DRAINING / FILLING. The **DRAINING / FILLING** windows opens. Select now the required procedure:

DRAINING / FILLING			
▶ Press 'DRAIN COUP. WATER' to empty the coupling water			
▶ Press 'DRAIN CUVETTE' to empty the cuvette with the aid of pressure			
▶ Press 'FILL COUP. WATER' to fill the coupling water			
DRAIN COUP. WATER	DRAIN CUVETTE	FILL COUP. WATER	BACK

- ▶ Press DRAIN COUP. WATER to empty the vessel automatically.
- ▶ Press DRAIN CUVETTE to empty the cuvette automatically.
- ▶ Press FILL COUP. WATER to fill the vessel with coupling water.

8.4.1 Draining the coupling water system

The coupling water can be removed automatically from the vessel, if required.

	ASSISTANCE
	<p>If the coupling water is contaminated by agar residues, it is recommended to drain the coupling water as long as it is warm. Alternatively, perform an automatic CLEANING procedure, see “8.3 Monthly CLEANING” on page 70.</p>

- ▶ Press DRAIN COUP. WATER. The **DRAINING** window opens:

DRAINING			
▶ Close vessel lid			
▶ Close adding and dispense port			
▶ Close safety cover			
Clean the level sensors after draining.			
START			BACK

- ▶ Close the vessel lid, the caps and the safety cover.
- ▶ Press START. The content of the vessel is pumped out.

- ▶ Press CONTINUE when the **PROCESS COMPLETED** window is displayed.
- ▶ Clean the coupling water level sensors after draining.
- ✓ The vessel is now emptied.

8.4.2 Draining the cuvette

- ▶ To remove media from the cuvette, e.g. in case of an erroneous medium preparation process, press DRAIN CUVETTE. The **DRAIN CUVETTE** window opens:

DRAIN CUVETTE			
<ul style="list-style-type: none"> ▶ Close vessel lid ▶ Connect dispensing tubing ▶ Close adding port ▶ Close safety cover ▶ Press 'START' to empty the cuvette with the aid of pressure 			
START			BACK

- ▶ Close the vessel lid and the adding port.
- ▶ Connect the fitting for dispensing tubing together with the silicone tubing to the dispense port. Let the end of the dispensing tubing hang into a container.
- ▶ Close the safety cover.
- ▶ Press START. The content of the cuvette is pumped out.
- ▶ Press ABORT when no more liquid is pumped out.
- ✓ The cuvette is now emptied.

8.4.3 FILLING the vessel with coupling water

- ▶ Prepare softened coupling water. Use deionized (DI), i.e. low lime water and add salt to fulfill the requirements for minimal conductivity (min. 10 µS/cm):

	MEDIACLAVE 10	MEDIACLAVE 30
Deionized (DI) water (grade 3 is sufficient)	2.7 l	8.5 l
Make it conductive with:		
• Tap water (must contain sufficient minerals) or	100 ml	200 ml
• 7 mg NaCl/l (a pinch of salt ≈ 40 mg)	19 mg	60 mg

	NOTICE
	The coupling water level detection in the vessel only works with clean level sensors and conductive deionized water! If non-conductive deionized water is used, a run cannot be started and during the automatic filling process with MC 30 the vessel may overflow.

MEDIACLAVE 10

FILL COUPLING WATER			
Circulation pump is activated.			
▶ Fill in fresh coupling water			
Upper level sensor: uncovered			
			BACK

- ▶ Select DRAINING / FILLING in the MAINTENANCE menu.
- ▶ Press FILL COUP. WATER. The **FILL COUPLING WATER** window opens.
- ▶ If the water does not circulate due to air in the coupling water system, press BACK and press FILL COUP. WATER again. Repeat this several times until the water circulates.

- ▶ Manually fill the vessel with coupling water. Approx. 2.7 liters of water have to be added to sufficiently fill up the coupling circulation system. Make sure that the lower coupling water level sensor is covered well by water, so that the circulation pump is activated. With cuvette inserted, the upper coupling water level sensor must be covered.

✓ The vessel is now filled.

MEDIACLAVE 30

FILL COUPLING WATER			
▶ Press 'MANUAL' to fill the coupling water manually			
▶ Press 'AUTOMATIC' for the automatic filling with the internal pump. (via Port 'COUPLING WATER INLET')			
MANUAL	AUTOMATIC		BACK

- ▶ Press FILL COUP. WATER to open the **FILL COUPLING WATER** window.
- ▶ Press MANUAL for starting the circulation pump or AUTOMATIC for the automatic filling process.

If you have pressed **MANUAL**,

- ▶ manually fill the vessel with softened coupling water. Approx. 8.5 liters of water have to be added to sufficiently fill up the coupling circulation system.

✓ The vessel is now filled.

If you have pressed **AUTOMATIC**,

- ▶ make sure that the cuvette is inserted. Otherwise the system will become overfilled.

FILL COUPLING WATER			
▶ Prepare enough of coupling water (Port 'COUPLING WATER INLET')			
▶ Press START for the automatic filling			
The filling procedure could take several minutes.			
START			BACK

- ▶ Connect the coupling water hose to the coupling water inlet at the rear side (see [“2.2.5 Rear panel”](#) on page 15) and the other end to the laboratory deionized water tap or to a water tank, filled with softened coupling water.

- ▶ Press **START**.

✓ The vessel will be automatically filled.

- ▶ Press **CONTINUE** when the **PROCESS COMPLETED** window appears.

8.5 Checking the safety valve

This procedure maintains and checks the proper function of the safety valve.

	ASSISTANCE
	<p>After 30 days or 50 runs since the last safety valve check, a safety valve reminder is displayed in the MAIN MENU. The safety valve test must be performed, otherwise the instrument will be locked after 10 further runs. To look up when the safety valve test is due, open the safety valve reminder under SYSTEM PARAMETER - INFO.</p>

- ▶ Press SAFETY VALVE in the **MAINTENANCE** window. The **SAFETY VALVE TEST** window opens.
- ▶ Insert the cuvette and fill the vessel with coupling water, see “8.4.3 FILLING the vessel with coupling water” on page 73.

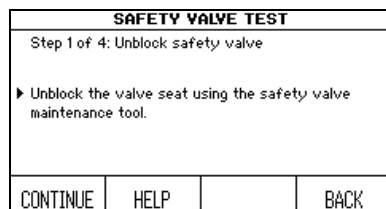

- ▶ Take safety valve maintenance tool, which is located on the right hinge of the safety cover. Unblock the valve seat by gently pushing the maintenance tool into the opening of the safety valve on the underside of the vessel lid.

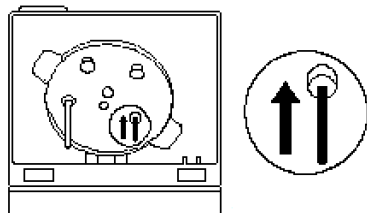

- ▶ For detailed information, hold the HELP button pressed.
- ▶ Press CONTINUE.

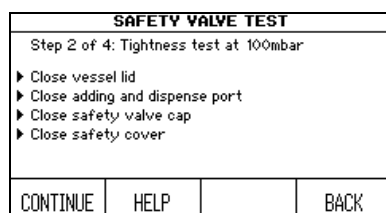

- ▶ Close the vessel lid and all ports. Ensure that the cap of the safety valve is firmly screwed clockwise.
- ▶ Close the safety cover and press CONTINUE.

The MEDIACLAVE performs a tightness test.

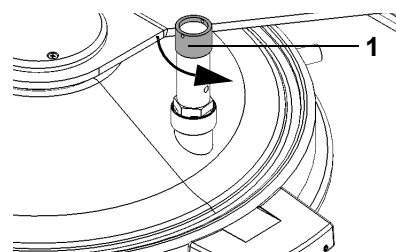

- ▶ When prompted, unscrew the cap of the safety valve counterclockwise (1). Move the cap upwards until feeling the spring tension to unblock the spring. Leave the cap open.
- ▶ Close the safety cover.
- ▶ Press CONTINUE to blow the safety valve.



During the process the safety valve blowing is audible as short sibilant evaporation sounds.

SAFETY VALVE TEST			
Step 4 of 4: Pressure test at 1bar			
▶ Close again the cap of the safety valve well (turn it clockwise)			
▶ Close safety cover			
CONTINUE	HELP		BACK

- ▶ Tighten the cap of the safety valve clockwise when prompted.
- ▶ Close the safety cover and press CONTINUE.

The MEDIACLAVE performs a pressure test which may take a few minutes.

- ✓ The safety valve is checked and operable, when “Safety valve test passed” is displayed. Please also check pivot pin disk, see [8.6](#).

	 WARNING
	<p>If the safety valve test was not completed successfully and the safety valve reminder is due, the MEDIACLAVE is locked for operation, because the safety feature of the safety valve is not guaranteed. Redo the test or call the service technician.</p>

8.6 Checking and replacing pivot pin disk

A regular check of the pivot pin disk ensures a silent operation and reduces wear and tear of stirrer bar and cuvette.

	ASSISTANCE
	Remove and inspect pivot pin disk every time safety valve test is due. (After 30 days or 50 runs).

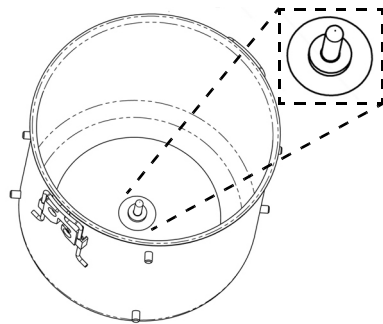

The white pivot pin disk (PTFE material) is located inside the bottom of the cuvette.

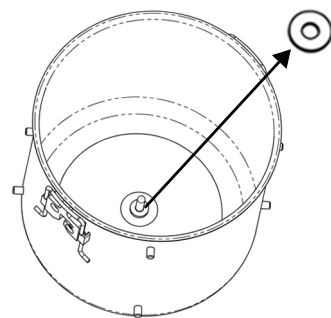

▶ Pull out the pivot pin disk by hand.

	NOTICE
	Never use a tool to remove the disk. The cuvette may be damaged.

The lifetime of pivot pin disk depends on frequency of use:

Frequency of use	Estimated lifetime
Standard users: <100 runs/month	approx. 3 months
Frequent users: 100-200 runs/month	approx. 2 months
Heavy users: > 200 runs / month	approx. 1 month

▶ The pivot pin disk must be replaced if its thickness is below 1 mm.

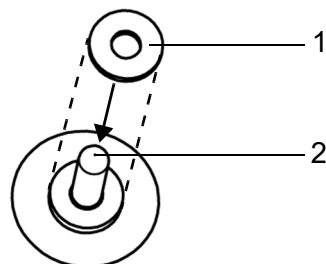

▶ Insert the disk (1) into the cuvette by putting it onto the pivot pin (2). Push it fully downwards to the bottom.

✓ The cuvette is ready for use.

8.7 Changing the printer paper roll



ASSISTANCE

The appearance of a red strip at the edge of the paper indicates the need of paper replacement.

To change the paper roll, proceed as follows:

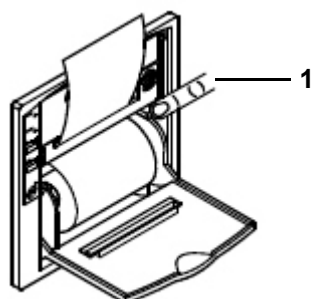
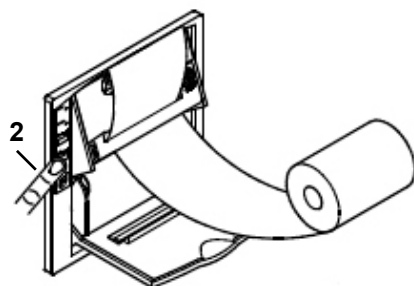
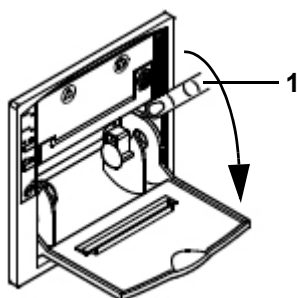

- ▶ Switch on the MEDIACLAVE, remove the printer splash guard and open the printer cover.
- ▶ Press the FEED key (2) to expel the last piece of paper and remove the empty bobbin.
- ▶ Press down the swinging support of the print mechanism at the point marked PUSH (1).
- ▶ Insert the evenly cut end of a new paper roll in the slit of the print mechanism and press the FEED key (2) to automatically feed a few centimeters of paper out of the printer.
- ▶ Insert the bobbin.
- ▶ Re-close the swinging support by pressing PUSH (1), insert the paper in the slit of the cover and re-close it.
- ▶ Tear off the paper and reattach the magnetic printer splash guard.
- ▶ Perform a print self-test by selecting **PRINTER TEST** as described in [“6.2.2 Process documentation by printer”](#) on [page 34](#).

✓ If the test print is printed out correctly, the printer is ready for use.

8.8 Exchanging the ink ribbon

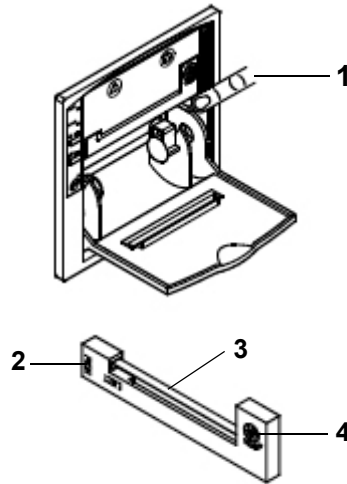

Exchange the ink ribbon cartridge as follows:



- ▶ Remove the printer splash guard and open the printer cover.
 - ▶ To remove the paper bobbin, press down the swinging support of the print mechanism at the point marked PUSH (1).
 - ▶ Tear out the paper end of the print mechanism.
 - ▶ Press PUSH (2) on the left side of the ink ribbon cartridge for ejection of the old cartridge.
 - ▶ Feed the new ink ribbon (3) in the small slot and press on the right side of the cartridge (4) to click it in.
-
- ▶ Reinsert the paper bobbin.
 - ▶ Reclose the swinging support by pressing PUSH (1) and reattach the magnetic printer splash guard.
 - ✓ The printer is ready for use.

8.9 Shipping to INTEGRA Biosciences

For any service or repairs, please contact your local service technician.

	 WARNING
	<p>MEDIACLAVE needs to be cleaned before sending it to service and the declaration on the absence of health hazards must be signed. This is necessary to protect service personnel.</p>

If the surface of the MEDIACLAVE has been in contact with biohazardous material, it must be decontaminated in accordance to good laboratory practice. Do not spray directly on the instrument but use a lint-free cloth, lightly soaked with a disinfectant and wipe dry directly after decontamination. Never use acetone or other solvents! Follow the instructions provided by the disinfectant manufacturer.

8.10 Disposal



MEDIACLAVE is labeled with the “crossed-out wheeled bin” symbol to indicate that this device must not be disposed of with unsorted municipal waste. It is your responsibility to correctly dispose of the waste products by handing them over to an authorized facility for separate collection and recycling. It is also your responsibility to decontaminate the products in the case of biological, chemical, or radioactive contamination so as to protect from health hazards the persons involved in the disposal or recycling of the products.

In certain regions and countries, e.g. in EU member states, the distributor is obliged to take back this product free of charge at the end of life. Please contact your local distributor for more details.

By doing so, you will help conserve natural resources and you will ensure that your waste products are recycled in a manner that protects human health and the environment. Thank you!

9 Technical data

9.1 Specification of the devices

	MEDIACLAVE 10	MEDIACLAVE 30
Dimensions and Weight		
Basic Device (H x W x D)	480 mm x 550 mm x 640 mm	1040 mm x 550 mm x 640 mm
Clearance overhead for cuvette handling	350 mm	600 mm
Clearance depth for water fittings (D)	70 mm	70 mm
Weight	57 kg	85 kg
Capacity		
Stainless steel cuvette	10 L, Ø 254 mm, H 237 mm, 2.2 kg	30 L, Ø 254 mm, H 671 mm, 5.4 kg
Media preparation capacity	1–10 L	3–30 L
Autoclave cuvette	Ø 254 mm, H 203 mm	-
Programming		
Storable programs	50	50
Temperature Range		
Sterilization	30°C–122°C	30°C–122°C
Dispensing	20°C–80°C	20°C–80°C
Water bath	30°C–80°C	30°C–80°C
Max. temperature deviation	+1.0°C/-0.2°C	+1.0°C/-0.2°C
Time (typical values for 10 L/30 L)		
Heating up (25°C–121°C)	37 min	38 min
Sterilization	0–99 min	0–99 min
Cooling down (121°C–50°C)	13 min	22 min
Total run time (sterilization time 15 min)	65 min	75 min
Stirrer		
Selectable speed for heating, sterilization or cooling phase of agar programs	100–200 rpm	100–200 rpm
Selectable speed for dispensing phase of agar programs	50–200 rpm	50–200 rpm
Selectable speed for water bath programs	0.50–200 rpm	0.50–200 rpm
Stirring direction modes	single, reversing	single, reversing

	MEDIACLAVE 10	MEDIACLAVE 30
Heating capacity	3 kW	9 kW
Utilities		
Graphic LCD-display	240 x 128 points	240 x 128 points
Interfaces	2x RS232, Ethernet, Footswitch, AUX contact, Ext. pinch valve USB port ^a	2x RS232, Ethernet, Footswitch, AUX contact, Ext. pinch valve USB port ^a
Cooling water connections	¾"	¾"
Cooling water temperature	5–25 °C	5–25 °C
Cooling water pressure range	(1) / 1.5 – 5 bar	1.5 – 5 bar
Cooling water minimal pressure	1.0 bar at 5 °C 1.0 bar at 15 °C 1.5 bar at 25 °C	1.5 bar at 5 °C 2.0 bar at 15 °C 2.5 bar at 25 °C
Cooling water quality	<2.0 mmol/L CaCO ₃ , <200 mg/L CaCO ₃ , i. e. <12 °dH (German), <14 °E (English) or <20 °fH (French).	<2.0 mmol/L CaCO ₃ , <200 mg/L CaCO ₃ , i. e. <12 °dH (German), <14 °E (English) or <20 °fH (French).
Deaeration outlet	drain required below instrument level	drain required on floor level
Coupling water connection	-	¾"
Coupling water supply	-	optional: 5–25 °C, 0–4 bar, self priming, minimal conductivity 10 µS/cm, see 8.4.3
Materials	Housing, cover: PUR Metallic surfaces: stainless steel	
Electricity supply		
All MEDIACLAVE 10 models	200–240 V, 50/60 Hz, 16 A, 3750 W	-
MEDIACLAVE 30 Part No. 136050	-	200–208 V 3~/PE, 50/60 Hz, 30 A, 9300 W
MEDIACLAVE 30 Part No. 136055	-	390–400 V 3~/N/PE, 50/60 Hz, 16 A, 9300 W
Plug version		
EF plug (EU)	CEE 7/7	
Nema plug (US)	NEMA L6-30P	

	MEDIACLAVE 10	MEDIACLAVE 30
Product life span		
Maximum	10'000 sterilization cycles ^b	10'000 sterilization cycles ^b





- a. Supported are USB flash drives formatted in FAT16 or FAT32 file systems only where the sector size is 512 bytes. No other file systems or sector sizes are allowed!
- b. Provided that maintenance and service is carried out regularly.



10 Accessories and consumables





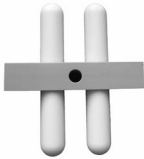
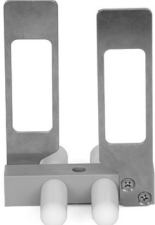
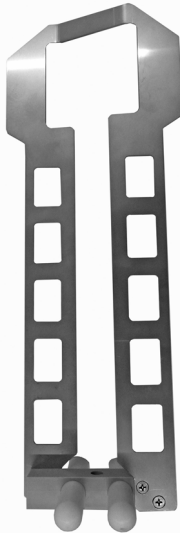

A variety of accessories are available, which adapt the MEDIACLAVE to the respective application requirements and working environments.





Purpose This chapter describes the available accessories and consumables.

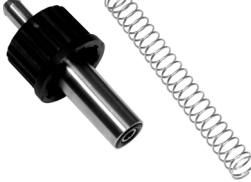

10.1 Accessories

Accessories	MEDIACLAVE	Part No.
	Stainless steel cuvette, for medium sterilization	10 136 030
	Stainless steel cuvette, for medium sterilization, incl. stainless steel guide tube for temperature probe	30 136 060
	Autoclave cuvette, for autoclaving/thermostating liquids in containers, stainless steel, incl. grid insert	10 136 498
	Autoclave kit, for autoclaving/thermostating liquids in containers, with autoclave cuvette, stainless steel, incl. grid insert and flexible temperature probe	10 136 070





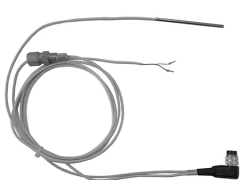

Accessories		MEDIACLAVE	Part No.
	<p>Magnetic stirrer bar, for homogeneous medium mixing within the cuvette</p>	10	132 130
	<p>Magnetic stirrer bar with paddle, for homogeneous stirring with MC 30 or for high-viscosity agar stirring with MC 10</p>	10 + 30	136 075
	<p>Magnetic stirrer bar with long paddle, for special applications with high-viscous media only. Please contact INTEGRA for support. Depending on viscosity reduce media volume. Turn “Alternate stirrer direction” OFF and reduce speed.</p>	30	136 080
	<p>Decanting tubing, for insertion into the cuvette for dispensing, incl. silicone tubing, stainless steel nozzle and securing nut</p>	10	136 034
	<p>Decanting tube, for insertion into the cuvette for dispensing, incl. rigid stainless steel tube (length 613 mm), silicone tubing and securing nut</p>	30	136 061

Accessories	MEDIACLAVE	Part No.
	<p>MC 30 Rapid dispensing kit - for dispensing of high-viscosity agar with DOSE IT. Including:</p> <ul style="list-style-type: none"> • Decanting tube large diameter (136072) • Fitting for dispensing tubing large diameter (136073) • Dispensing nozzle (136074) • Tubing set for double pump head (171088) 	<p>30 136 071</p>
	<p>Decanting tube large diameter - for insertion into the cuvette for dispensing high-viscosity agar, incl. rigid stainless steel tube, silicone tubing and securing nut</p>	<p>30 136 072</p>
	<p>Fitting for dispensing tubing large diameter (ID 10 mm)</p>	<p>30 136 073</p>
	<p>Dispensing nozzle for rapid dispense kit (ID 10 mm tubing)</p>	<p>30 136 074</p>
	<p>Tubing set for double pump head of DOSE IT (2x 16 cm tubing ID 8 mm, 2x 1.5 m tubing ID 10 mm)</p>	<p>30 171088</p>
	<p>Fitting for dispensing tubing, for connecting tubing to dispense port, incl. stainless dispense port fitting and spring</p>	<p>10 + 30 136 035</p>
	<p>Printer splash guard, for protecting the integrated printer from splashes</p>	<p>10 + 30 136 040</p>

Accessories	MEDIACLAVE	Part No.
	<p>Tubing connector for adding port, for adding large volumes of supplements through the adding port using a silicone tubing</p>	<p>10 + 30 136 049</p>
	<p>Adding port cap GL32</p>	<p>10 + 30 136 032</p>
	<p>Dispense port cap GL25</p>	<p>10 + 30 136 033</p>
	<p>Injection lid, for sterile injection of supplements through the adding port, incl. cap, punched disc and septum membrane</p>	<p>10 + 30 136 247</p>
	<p>Pressure dispensing kit, for direct pressure dispensing, incl. pinch valve box, foot switch, silicone tubing, stainless steel dispensing tube and operating instructions</p>	<p>10 + 30 136 064</p>
	<p>Aspiration/dispensing tube, for pressure dispensing, length 10 cm, inner diameter 6 mm, stainless steel, one end dented</p>	<p>10 + 30 171 056</p>
	<p>Foot switch with connection cable, for pressure dispensing, to trigger the pinch valve</p>	<p>10 + 30 143 200</p>
	<p>Volume measuring stick, for convenient measurement of the product volume in the cuvette</p>	<p>30 136 565</p>
<p>Water outlet hose, for draining of cooling and coupling water, to be connected to the water outlet, 2 m length</p>		<p>10 + 30 136 042</p>
<p>Cooling water hose, for cooling of the device with tap water, to be connected to the cooling water inlet, 2 m length, fitting 3/4 inch</p>		<p>10 + 30 136 043</p>

Accessories		MEDIACLAVE	Part No.
Strainer for cooling water hose		10 + 30	136 045
Deaeration hose , for deaeration of the device, to be connected to the deaeration outlet, 2 m length		10 + 30	136 044
Coupling water inlet hose , for automatic filling of the vessel with coupling water, to be connected to the coupling water inlet, 2 m length		30	136 062
Safety valve maintenance tool		10 + 30	136 995
	T-probe medium semi-rigid 10L	10	136 978
	T-probe medium flexible	10 (AUTOCLAVE mode) and 30	136 979
	Double temperature probe , flexible (PT1000 for MEDIACLAVE / PT100 for external)	10 + 30	136 065
USB flash drive		10 + 30	136 068

10.2 Consumables

Consumables		MEDIACLAVE	Part No.
	Lid seal , for sealing the vessel lid, silicone	10 + 30	135 860
	Septum membrane , for injection lid, silicone/PTFE, self-resealing, 10-pack. Can be used as seal for Adding port cap.	10 + 30	136 047
	Paper rolls , for integrated dot matrix printer, 10-pack	10 + 30	136 038
	Ink ribbon , for integrated dot matrix printer	10 + 30	136 901
	Silicone tubing , for pressure dispensing, length 25 m (bulk roll), inner diameter 6 mm, autoclavable	10 + 30	171 036
	Pivot pin disk , PTFE for cuvette 10/30L (6-pack), to reduce noise and wear and tear of stirrer bar and cuvette.	10 + 30	136 066

11 Appendices

11.1 Glossary

Purpose This chapter informs about some important expressions used in this operating instruction manual.

ADDING PORT	Port on the vessel lid used for adding supplements to the medium (e. g. blood for chocolate agar).
AMSL	Above mean sea level.
ARROW KEYS	Keys situated beside the GUI and used to change parameters.
AUTOCLAVE	Operation mode that allows to use the MEDIACLAVE 10 as a bench-top autoclave for media in glassware only!
AUTOCLAVE CUVETTE	Special cuvette needed to use the autoclave mode of the MEDIACLAVE 10 .
BURST DISC	Safety disc that serves as an additional safety feature if microprocessor control and overpressure safety fail.
COMPRESSION FITTING	Mounting of the temperature probe at the top of the vessel lid.
CONNECTION CHART	Label on the rear side of the MEDIACLAVE explaining the function of the rear panel interfaces.
COUPLING WATER	Water jacket between vessel and cuvette. Minimal conductivity must be ensured. The two upper and lower coupling water level sensors (25) use the conductivity of the coupling water to detect presence of fluid.
CUVETTE	Pot in which culture media are prepared when using the MEDIACLAVE programs. Is also used for prewarming and preswelling culture media in the WATER BATH operation mode. The cuvette has to be placed into the vessel.
CYCLE COUNTER	Counts all processed programs.
DECANTING TUBING	Tubing on the underside of the vessel lid, hanging down in the cuvette, used for aspiration of culture media.
DISPENSE PORT	Port on the vessel lid for dispensing media.
DISPENSING TUBING	Silicone tubing to be fixed onto the fitting for dispensing tubing, used to dispense culture media.

FEED	Button on MEDIACLAVE printer used for scrolling printer paper.
FITTING FOR DISPENSING TUBING	Fitting for dispensing tubing with stainless spring, to be screwed onto the dispense port on the top of the vessel.
FUNCTION KEYS	Keys situated below the GUI and used to select screen options.
GRAPHICAL USER INTERFACE (GUI)	Consists of a graphic display and six soft keys below and beside the display.
INJECTION LID	Lid with septum membrane, for sterile injection of supplements through the adding port.
LID SEAL	Silicone seal inside the vessel lid, essential for tightness.
LIMS	Laboratory Information Management System (LIMS): computer software for the management of samples, users, instruments and other functions in a laboratory.
MAGNETIC STIRRER BAR	Magnet bar that is inserted into the cuvette. Necessary to reach homogeneous temperature.
MAINTENANCE	Programs associated with the cleaning, draining and filling of the MEDIACLAVE.
NEXT PHASE	This program function enables the operator to interrupt a cycle phase manually and proceed to the next phase of the program cycle. This function can not be used during the heating phase and during the cooling phase.
OPERATING ENVIRONMENT	Recommended conditions (such as temperature and humidity) under which the MEDIACLAVE is to be operated and transported.
OPERATION MODE	Type of program in which the MEDIACLAVE runs, e. g. STANDARD or WATER BATH.
PARAM. LOG	MEDIACLAVE device parameters Log file with device and service info, etc..
PINCH VALVE BOX	Part of the pressure dispense kit. Optional accessory to dispense the product by pressure.
PIVOT PIN DISK	Disk which protects the pivot pin from frictional wear caused by the stirrer bar and reduces noise.
PRESSURE DISPENSING KIT	Kit including pinch valve box, foot switch, silicone tubing and stainless steel dispensing tube for direct pressure dispensing.

PRINTER SPLASH GUARD	Protects the printer from splashes.
PROGRAM CYCLE	An entire operation process with all program phases.
PROGAM.LOG	MEDIACLAVE log file with program parameter settings.
PROGRAM PHASE	Refers to periods during a program cycle. These include heating-up, sterilizing, cooling down, dispensing, etc..
PROGRAMS	MAIN MENU option to define, adapt, store and execute up to 50 individual programs.
PT 1000 TEMPERATURE PROBE	Temperature sensor for the product, e. g. media. For the AUTOCLAVE mode (MEDIACLAVE 10 only) a flexible temperature probe is required.
RUNxxxxx.LOG	The RUN data log file contains program parameters and process data as sterilization temperature, time and pressure.
SAFETY COVER	Cover to protect the operator against access to vessel lid when the temperature is above 80 °C. Open/Close status is monitored by a sensor.
SAFETY COVER LOCK	Bolt which locks the safety cover, controlled by a sensor.
SAFETY VALVE	Limits pressure within the vessel to 1.70 bar (+10 % tolerance) and is located on the vessel lid.
SYSTEM.LOG	Log file (log book) with system data. For diagnostic purposes, the log book records all kind of status information during MEDIACLAVE operation.
SYSTEM PARAMETER	Access to the general device parameter in the MAIN MENU.
TEST PRINT	Performance test that checks the functionality of the printer.
TIGHTNESS TEST	Built-in safety function at the beginning of a MEDIACLAVE cycle.
TUBING CONNECTOR FOR ADDING PORT	Optionally available adapter for adding large volumes of supplements by means of a pump, e. g. DOSE IT.
TYPE PLATE	Positioned at the rear of the MEDIACLAVE. It lists specified mains voltage, power consumption, type and serial number.
VESSEL	Sterilization chamber in which the cuvette can be entered.

VESSEL LID	Stainless steel lid with adding and dispense ports, temperature sensor and safety valve. The lid and the vessel are locked with a bajonet mechanism.
VESSEL LID GRIPS	Mounted on the MEDIACLAVE vessel lid, which are turned anticlockwise to open the vessel lid.
WATER BATH	Program for thermostating liquids in glasswares with autoclave cuvette (only MEDIACLAVE 10) or to prewarm culture media for the efficient dissolving prior to sterilization.

Imprint

© 2024 INTEGRA Biosciences AG

All rights to this documentation are reserved. In particular the rights of reproduction, processing, translation and the form of presentation lie with INTEGRA Biosciences AG. Neither the complete documentation nor parts thereof may be reproduced in any way, or stored and processed using electronic media or distributed in any other way without the written consent of INTEGRA Biosciences AG.

Every effort has been made to provide complete and accurate information in this manual. Although this manual should contain a specifically labeled warranty notice for the product, INTEGRA Biosciences AG makes no representations or warranties with respect to the contents of this manual and reserves the right to change this manual without notice if and when improvements are made.

INTEGRA Biosciences AG shall not be liable for any loss, damage, repair costs, incidental or consequential damages of any kind, whether based on express or implied warranty, contract, omission or strict liability, arising in connection with the design, development, installation or use of the products.

INTEGRA Biosciences AG aims to provide reliable and accurate data and documentation. If you find a discrepancy, we would be grateful for your assistance and ask you for email us at info@integra-biosciences.com.

These operating instructions have the part number 136 950; the version is V20. They apply for software Version 2.23 or higher until a newer revision is released.

Manufacturer and customer service Your local INTEGRA Biosciences representative, further information, and operating instructions in other languages can be found at www.integra-biosciences.com or are available on request info@integra-biosciences.com.

Manufacturer

INTEGRA Biosciences AG

Tardisstrasse 201
CH-7205 Zizers, **Switzerland**
T +41 81 286 95 30
info-ch@integra-biosciences.com

INTEGRA Biosciences Corp.

22 Friars Drive
Hudson, NH 03051, **USA**
T +1 603 578 5800
info-us@integra-biosciences.com

Direct Sales Country

Integra Biosciences PTY Ltd

Unit 55, 193-203 South Pine Road
Brendale QLD 4500, **Australia**
T +617 3497 5800
info-au@integra-biosciences.com

INTEGRA Biosciences (Shanghai) Co., Ltd.

Room 1110, No. 515 Huanke Road
Shanghai 201315, **China**
T +86 21 5844 7203
info-cn@integra-biosciences.com

INTEGRA Biosciences Nordic ApS

Vallensbækvej 22A 3TV
Brøndby 2605, **Denmark**
T +45 3173 5373
info-nordic@integra-biosciences.com

INTEGRA Biosciences SAS

8 avenue du Fief
95310 Saint Ouen l'Aumône, **France**
T +33 1 34 30 76 76
info-fr@integra-biosciences.com

INTEGRA Biosciences Deutschland GmbH

An der Amtmannsmühle 1
35444 Biebertal, **Germany**
T +49 6409 81 999 15
info-de@integra-biosciences.com

INTEGRA Biosciences KK

Higashikanda 1-5-6, Chiyoda-ku
Tokyo, 101-0031, **Japan**
T +813 5962 4936
info-jp@integra-biosciences.com

INTEGRA Biosciences Benelux BV

Smederijstraat 2
4814 DB Breda, **Netherlands**
T +31 630 609 866
info-benelux@integra-biosciences.com

INTEGRA Biosciences Ltd

2 Rivermead Business Park
Thatcham, Berks, RG19 4EP, **United Kingdom**
T +44 1635 797 00
info-uk@integra-biosciences.com
