

INTEGRA



VIAFLO 96
VIAFLO 384

Operating instructions



Declaration of conformity

INTEGRA Biosciences AG – 7205 Zizers, Switzerland

declares on its own responsibility that the devices

Description	Models
VIAFLO 96	6000, 6001
VIAFLO 384	6030, 6031

comply with:

EU Directives	Scope	Date effective
2014/35/EU	Low voltage directive (LVD)	20.04.2016
2014/30/EU	Electromagnetic compatibility (EMC)	20.04.2016
2012/19/EC	Waste electrical and electronic equipment (WEEE)	14.02.2014

2011/65/EC	Restriction of hazardous substances (RoHS)	03.01.2013
------------	--	------------

EU Regulations	Scope	Date effective
1907/2006	Registration, evaluation, authorisation and restriction of chemicals (REACH)	01.06.2007

EU Standards	Scope
EN 9001:2015	Quality Management
EN 61010-1:2020	Safety general laboratory equipment
EN 61326-1:2013	Electromagnetic compatibility laboratory equipment
EN 61010-2-081:2020	Safety automatic laboratory equipment

GBR Regulations	Scope	Date effective
S.I. 2016/1101	Electrical equipment safety	08.12.2016
S.I. 2016/1091	Electromagnetic compatibility (EMC)	08.12.2016
S.I. 2013/3113	Waste electrical and electronic equipment (WEEE)	01.01.2019
S.I. 2012/3032	Restriction of hazardous substances (RoHS)	02.01.2013

GBR Standards	Scope
BS 61010-1:2010	Safety general laboratory equipment
BS 61010-2-081:2020	Safety automatic laboratory equipment
BS 63000:2018	Restriction of hazardous substances (RoHS)

VIAFLO 96/384 – Declaration of conformity

USA Regulations	Scope
47 CFR Part 15 (FCC)	Electromagnetic compatibility (EMC)
17 CFR Parts 240 & 249b	Dodd frank “Conflict minerals”
27 CCR Parts 25102-27001	Proposition 65: The safe drinking water and toxic enforcement act
TSCA 40 CFR Part 751	Toxic substances control act

USA Standards	Scope
UL 61010-1:2012	Safety general laboratory equipment
UL 61010-2-081:2019	Safety automatic laboratory equipment

CAN Standards	Scope
CSA-C22.2 No. 61010-1	Safety general laboratory equipment
CSA C22.2 No. 61010-2-081	Safety automatic laboratory equipment

CHN Regulations	Scope	Date effective
Order 32/2016	Restriction of hazardous substances (RoHS)	01.07.2016

CHN Standards	Scope
SJ/T 11364-2014	Restriction of hazardous substances (RoHS)

EAC Технический регламент Таможенного союза	
TP TC 004/2011	О безопасности низковольтного оборудования
TP TC 020/2011	Электромагнитная совместимость технических средств

International Standards	
ISO 8655-2	Piston pipettes

Zizers, 2023-12-08

Urs Hartmann
CEO



Daniela Gross
Head of Corporate Quality

Table of Contents

Chapter 1	Introduction	
1.1	Symbols used.....	7
1.2	Intended use.....	7
1.3	Safety notes	8
Chapter 2	Description of the device	
2.1	Scope of delivery.....	10
2.2	Overview of VIAFLO 96/384.....	10
2.2.1	VIAFLO 96/384 device.....	10
2.2.2	VIAFLO 96/384 control unit.....	11
2.2.3	Display	11
2.2.4	Touch wheel.....	12
2.2.5	Left and right arrow buttons	12
2.2.6	PURGE button	12
2.2.7	RUN button	12
Chapter 3	Installation	
3.1	Operating environment.....	13
3.2	Setting up and moving of the instrument.....	13
3.3	Getting started	14
3.4	Toolbox - adapt your VIAFLO 96/384.....	15
3.4.1	Change head	15
3.4.2	Storage of pipetting heads.....	16
3.4.3	Position Settings	17
3.4.4	Preferences.....	18
3.4.5	Calibration & Services.....	20
3.4.6	Communications	21
3.4.7	Device Information.....	21
3.4.8	Language	21
3.4.9	Write protect.....	22

Chapter 4 Operation

4.1	Turn on/off the device.....	23
4.2	Attaching and removing GRIPTIPS.....	23
4.2.1	Loading tips from a complete rack.....	24
4.2.2	Partial tip loading.....	24
4.2.3	Ejecting used GRIPTIPS.....	25
4.3	Start pipetting.....	25
4.3.1	Pipetting.....	25
4.3.2	Set Z-Position.....	25
4.3.3	Blowout/blowin modes.....	26
4.3.4	Recommendations for pipetting.....	27
4.4	Pipetting options and settings.....	28
4.4.1	Edit option.....	28
4.4.2	Volume selection.....	28
4.4.3	Speed selection.....	29
4.4.4	Custom.....	30
4.4.5	Pace.....	30
4.4.6	Count, Mix Cycle and Rows.....	30
4.4.7	Pipetting between 24-96 and 96-384 well plates.....	31
4.4.8	Pipetting with the three position stage.....	32
4.5	Troubleshooting/FAQ.....	33

Chapter 5 Pipetting modes

5.1	Overview pipetting modes.....	34
5.2	Detailed description of pipetting modes.....	35
5.2.1	Pipet mode.....	35
5.2.2	Repeat dispense mode.....	36
5.2.3	Sample dilute mode.....	37
5.2.4	Pipet/mix mode.....	37
5.2.5	Manual pipet mode.....	38
5.2.6	Reverse pipet mode.....	39
5.2.7	Variable dispense mode.....	40
5.2.8	Multi aspirate mode.....	41
5.2.9	Sample dilute/mix mode.....	42
5.2.10	Serial dilution mode.....	43
5.3	Custom step-based programming mode.....	44
5.3.1	Manual custom program.....	45
5.3.2	Modify existing programs.....	48
5.3.3	Automatic custom program.....	48
5.4	VIALINK.....	50

Chapter 6 Maintenance

6.1	Cleaning and Decontamination	51
6.1.1	Cleaning	51
6.1.2	Decontamination	51
6.2	Prolonged period of non-use	51
6.3	Leak test	52
6.4	Servicing	53
6.4.1	Blocked pipetting unit	53
6.4.2	Changing O-rings of tip fittings	54
6.5	Calibration	55
6.6	Equipment disposal	55

Chapter 7 Technical data

7.1	Environmental conditions	56
7.2	Specification of the device	56
7.3	Intellectual property	57
7.4	Pipetting specifications	58
7.5	Pipetting speeds	59

Chapter 8 Accessories and consumables

8.1	Accessories	60
8.2	Consumables	62
8.3	GRIPTIPS	64
8.3.1	INTEGRA pipetting device	64
8.3.2	Package options	64
8.3.3	GRIPTIP properties	64
	Imprint	65

1 Introduction

VIAFLO 96 and VIAFLO 384 are separate instruments. The abbreviation VIAFLO 96/384 is used if information is relevant to both instruments. These operating instructions contain all the information required for installation, operation and maintenance of VIAFLO 96/384. This chapter informs about the symbols used in these operating instructions, the intended use of VIAFLO 96/384 and the general safety instructions.

1.1 Symbols used

The operating instructions specifically advise of residual risks with the following symbols:

**WARNING**

This safety symbol warns against hazards that could result in injury. It also indicates hazards for machinery, materials and the environment. It is essential that you follow the corresponding precautions.

**CAUTION**

This symbol cautions against potential material damage or the loss of data in a microprocessor controller. Follow the instructions.

**NOTE**

This symbol identifies important notes regarding the correct operation of the device and labor-saving features.

The device is marked with the following symbols:

**BIOHAZARD**

The instrument can be potentially biohazardous due to the use of biohazardous substances by the operator.

**CRUSHING OF HANDS**

The hands may be squeezed, pulled in or otherwise injured by moving parts of the instrument.

**UNPLUG**

The power cable must be unplugged before the housing of the instrument is opened by a service technician.

1.2 Intended use

VIAFLO 96/384 is an electronic 96/384 channel hand held pipette designed for aspirating and dispensing aqueous solutions in the volume range of 0.5 µl to 1250 µl using GRIPTIP pipette tips. VIAFLO 96/384 is used like a hand held pipette. The movement and positioning of the 24, 96, 384 channel pipette is supported by a servo assisted steering mechanism which allows fast, precise and stress free multichannel pipetting. VIAFLO 96 can be used with 24 and 96 channel pipetting heads, while VIAFLO 384 is compatible with 24, 96, and 384 channel pipetting heads.

Any use of this instrument in a medical or IVD setting is the responsibility of the user.

If VIAFLO 96/384 is used in a manner not specified by INTEGRA Biosciences, the protection provided by the VIAFLO 96/384 may be impaired.

1.3 Safety notes

VIAFLO 96/384 complies to the recognized safety regulations and is safe to operate. VIAFLO 96/384 can only be operated when in perfect condition and while observing these operating instructions.

The device may be associated with residual risks if it is used or operated improperly by untrained personnel. Any person operating the VIAFLO 96/384 must have read and understood these operating instructions, and particularly, the safety notes, or must have been instructed by supervisors so that safe operation of the device is guaranteed.



WARNING

Do not use the VIAFLO 96/384 near flammable material or in explosive areas. Also, do not pipette highly flammable liquids such as acetone or ether.

When handling dangerous substances, comply with the material safety data sheet (MSDS) and with all safety guidelines such as the use of protective clothing and safety goggles.

Only use GRIPTIPS® brand pipette tips to ensure the proper function of the VIAFLO 96/384 and to comply with the general warranty conditions. Damage to the pipette and risk to operator's health and safety may result from using non-specified pipette tips.



CAUTION

Do not immerse the pipetting head in liquid. The fluid can damage internal parts. Avoid pipetting of liquids whose vapors could attack the materials PA (polyamide), POM (polyoxymethylene), FPM (fluor-rubber), NBR (nitrile-rubber), CR (chloroprene), silicone. Corrosive vapors could also damage metallic parts inside the device.

Do not open or modify VIAFLO 96/384 in any way. The sheet metal must not be removed. Repairs may only be performed by INTEGRA Biosciences AG or by an authorized after-sales service member.

Parts may be replaced with original INTEGRA Biosciences parts only.

Never insert the mains adapter of any INTEGRA electronic hand pipette into the power connector of the control unit (5).



NOTE

Prolonged exposure of the VIAFLO 96/384 to UV-light can cause discoloration and/or yellowing of the control unit. However, this will not affect the performance of the device in any way.

Regardless of the listed safety notes, additional applicable regulations and guidelines of trade associations, health authorities, trade supervisory offices, etc. must be observed.

Please visit our website www.integra-biosciences.com on a regular basis for up to date information regarding REACH classified chemicals contained in our products.

2 Description of the device

2.1 Scope of delivery

- VIAFLO 96/384 device
- Power cable
- USB cable type A to B
- Operating instructions



CAUTION

Verify the scope of delivery when unpacking the device and check for potential transportation damage. Do not operate a device that is damaged, instead contact your local INTEGRA representative.

2.2 Overview of VIAFLO 96/384

2.2.1 VIAFLO 96/384 device

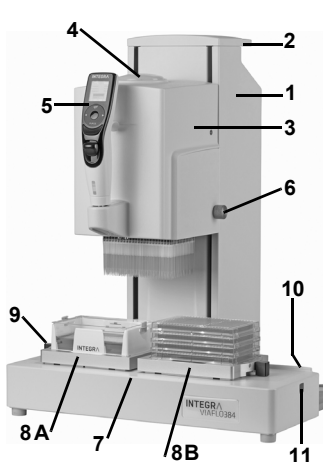

- 1 **Base unit**, to move left and right (X axis)
- 2 **Carrying handle** of base unit
- 3 **Pipetting unit**, to move up and down (Z axis)
- 4 **Tip load button**
- 5 **Control unit**, see [2.2.2](#)
- 6 Knob of **Side cover**, covers the pipetting head
- 7 **Instrument deck**
- 8 **Plate holders on position A and B**
- 9 **Plate slider**, with front and back positions (Y axis) to index 96 well plates with 24 channel head or 384 well plates with 96 channel head and zero position for plates corresponding to the head size
- 10 **Main switch**
- 11 **USB-B port**, to connect to PC

2.2.2 VIAFLO 96/384 control unit



- 12 **Display**
- 13 **Back button**, to navigate backward
- 14 **Touch wheel**, spin to scroll and move the cursor
- 15 **OK button**, to make a selection
- 16 **Left and right arrow buttons**, for selections
- 17 **PURGE button**, to empty tips
- 18 **RUN button**, to start operations
- 19 **Tip ejector**
- 20 **Finger hook**, facilitates easy operation

2.2.3 Display

The Display shows all pipetting options.

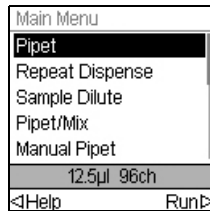

OK

Current mode	Pipet			
Active step	Press RUN to go.	Instruction		
	Aspirate 12.00µl	Volumes		
	Dispense 12.00µl			
	<table border="1"> <tr> <td>Edit</td> </tr> <tr> <td>Speed: 8</td> </tr> </table>	Edit	Speed: 8	Options
Edit				
Speed: 8				
	<168.5 A Z ↓ B 49.4>	Arrow buttons to set Z height		

2.2.4 Touch wheel

The **touch wheel** is fully operational with only one hand. Rotational finger movements translate into up and down cursor movement on the display. The **touch wheel** is fully functional with the use of latex gloves.

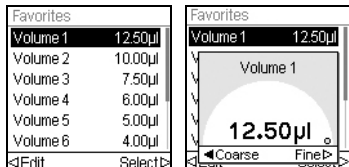

Move finger on the **touch wheel** to choose (and highlight) an option on the display. Press **OK** (15) to make the selection.

When a setting dial is displayed, spin the **touch wheel** to change the value and press **OK**.

2.2.5 Left and right arrow buttons

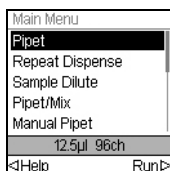

At times, you will see < and > on a display screen. These buttons are used to select options.

Press < to select the option indicated with the left arrow (HELP, in the example beside). Press > to select the option indicated with the right arrow (RUN, in the example).

2.2.6 PURGE button

During pipetting, you can interrupt the current pipetting protocol and purge all remaining liquid currently in the GRIPTIPS. To do so, press **PURGE** (17).



The pipette will display a prompt.

To proceed, press and release **RUN** (18). Upon completion of the dispense, the first step in the current program will be displayed.

2.2.7 RUN button

Press and release the **RUN button** (18) to initiate aspiration, dispense, mix, purge, and special pipetting operations.

During dispense, you can press and hold **RUN** to perform a two-step blowout, see [“4.3.3 Blowout/blowin modes”](#) on page 26.

3 Installation

3.1 Operating environment

VIAFLO 96/384 has been designed for use in a laboratory. It shall be operated in a dry and dust-free location with a temperature of 5–40 °C and a maximal (non-condensing) relative humidity of 80 %.

3.2 Setting up and moving of the instrument

The VIAFLO 96/384 must be set up on a cleaned, dry and horizontal surface.

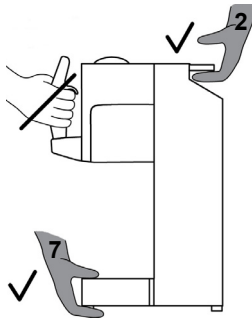

Hold the **carrying handle** (2) and the **instrument deck** (7) to lift VIAFLO 96/384.



WARNING

The device must not be carried on the control unit because it will be damaged.

Leave at least 5 cm of free space on the back for air circulation and to allow easy connection of the mains cable.



WARNING

It must always be possible to manually disconnect the plug of the VIAFLO 96/384 from electricity supply. The corresponding socket shall be within easy reach of the operator and be clearly labeled as the disconnecting device of VIAFLO 96/384.

Only use a 3 core mains cable with protective earth to connect VIAFLO 96/384 with the power source. The socket is located on the reverse side of the instrument deck.

Put the **plate holders** (8) on the **instrument deck** (7) on **position A** and/or **B**. They can both be placed on either side. Move the **plate holder** from left to right until the two bolts click into the two holes.

Alternatively, put the three position stage on the **instrument deck** (7) until the bolts click into the four holes, see [“8.1 Accessories”](#) on page 60).

**WARNING**

VIAFLO 96/384 must be secured with the “Park Head” function before carrying.

Before VIAFLO 96/384 can be relocated, the pipetting and base unit must be fixed. Select “Park Head” from “Calibration & Service” of the Toolbox menu, see “3.4.5 Calibration & Services” on page 20. Make sure GRIPTIPS have been ejected, clear the **instrument deck (Z)** and press **RUN (18)** to start the park routine. The unit moves to the park position and is anchored on the base with a bolt. Switch off VIAFLO 96/384 and disconnect it from the electricity mains.

3.3 Getting started

Turn on VIAFLO 96/384 (see “Turn on/off the device” on page 23). To adapt the device to the appropriate applications, select the following functions of the Toolbox menu in this order:

- **Change head:** Select the toolbox menu “Change head” and insert the appropriate pipetting head, see “Change head” on page 15.
- **Load 96/384 GRIPTIPS,** see “Attaching and removing GRIPTIPS” on page 23
- **Position settings - Head alignment:** Define the center of the wells of a 96 or 384 well plate, see “Position Settings” on page 17.
- **Position settings - Tip align:** VIAFLO 96/384 base unit can be moved left and right (X direction). Tip align locks onto the wells of a plate and helps to guide the tips into the microplate wells.
- **Z Height:** VIAFLO 96/384 pipetting unit can be moved up and down (Z direction). A minimum height can be defined in every pipetting mode, e. g. to set optimal tip immersion depth, see “4.3.2 Set Z-Position” on page 25.
- **Preferences:** Define system parameters, see “Preferences” on page 18.

3.4 Toolbox - adapt your VIAFLO 96/384

The Toolbox provides options to adapt the device to appropriate applications, setting personal preferences, calibration, computer connectivity and storing owner information.

Toolbox mode	Description
Change Head	Allows to change the pipetting head.
Position Settings	Sets the tip alignment, head alignment and Z height.
Preferences	Customizes the system parameters.
Calibration & Service	Sets calibration and service history options and parks the head.
Communications	Enables communication between your VIAFLO 96/384 and a PC.
Device Information	View your pipette's serial number, software version and set a personal ID.
Language	Sets display language.
Write Protect	Protects programs or menu options from modification.

The Help information describes the modes and some settings, press <1 to select the Help option.

3.4.1 Change head



NOTE

VIAFLO 96 can be used with 24 and 96 channel pipetting heads, while VIAFLO 384 is compatible with 24, 96 and 384 channel pipetting heads.

The following pipetting heads are available:

Pipetting head	Channels	Volume range
300 µl	24	10–300 µl
1250 µl	24	50–1250 µl
12.5 µl	96	0.5–12.5 µl
50 µl	96	2–50 µl
125 µl	96	5–125 µl
300 µl	96	10–300 µl
1250 µl	96	50–1250 µl
12.5 µl	384	0.5–12.5 µl
50 µl	384	2–50 µl
125 µl	384	5–125 µl

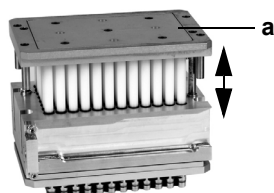

Remove the pipetting head from the case.

Make sure the pipetting head is in extended position (see image to the left). If necessary, pull apart the **piston plate** (a) on the top as far as possible.

To install the appropriate pipetting head select the Toolbox option “Change Head”.

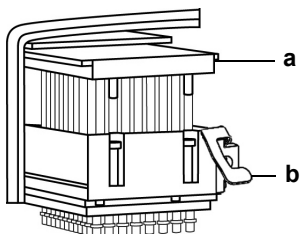

Loosen the knob and remove the **side cover** (6).

Remove the existing head, if installed.

Push the appropriate pipetting head into the slide block and make sure the **piston plate** (a) slides onto the brazen rails.

Mount the **side cover**, screw the knob tightly and press **OK** to continue.



NOTE

Pipetting heads with a serial number >50274 feature an ejection lever (b) to facilitate the removal of the head. Pull up the lever to loosen the pipetting head, then remove it from the instrument.

Check whether the Pipet factor on the display corresponds to the Pipet factor labeled on the side of the head itself or indicated in the latest calibration certificate. Press OK ▷ if the factors coincide. If they don't, click ◀ Edit.

Change Head		Change Head	
Current factors:		Pipet Factor	
Pipet	0.9804	Pipet Factor	0.9804
Repeat	1.0081		(0.9000 - 1.1000)
12.5µl 96ch		◀Reset	OK▷
◀Edit	Save▷		

With the factor “Pipet” selected click ◀ Edit to change the Pipet factor accordingly. Using the **touch wheel**, select the digit to be modified, then press **OK** and use the **touch wheel** to select a number. Press **OK** to confirm. Once finished, press Save ▷ to apply the correct Pipet factor to the instrument.

◀ Reset sets the factor to 1.0000. Changing the factor “Repeat” is only necessary under special circumstances. Refer to the calibration document (PROTO_VIAFLO96_384_calibration), available on request.

3.4.2 Storage of pipetting heads

Once a pipetting head is removed from VIAFLO 96/384 it must be stored in the appropriate casing to protect it from dust and mechanical damage.



CAUTION

Pipetting heads with 384 channels must always be stored in extended position.

3.4.3 Position Settings

Position settings contain options that help to find correct pipetting positions. These settings are globally stored and are valid for all pipetting heads. Perform these alignments with GRIPTIPS attached, see [“4.2 Attaching and removing GRIPTIPS”](#) on page 23.

Position settings	Description	Range
Tip Align	<p>Optimally aligns the tips to target the center of the wells on a 96 or 384 well plate.</p> <ul style="list-style-type: none"> • Select Position A or B and press OK to activate the tip alignment. • Highlight the Strength option and press OK. Set alignment support strength 1 (low) to 3 (high). Press OK. • Column Detent activates column positions of a plate on Position A or B, e. g. for serial dilutions. Press OK. Press ▷ to save. 	<p>✓/* (On/Off) 1-3</p> <p>* (Off) ✓ (A or B)</p>
Head Alignment	<p>Use a 96 well plate for a 96 channel and a 384 well plate for a 384 channel pipetting head to define the center of the wells (for 24 channel head see below). This setting is required only once per pipetting head. Move the unit to Position A or B until the selected position, e.g. A, is displayed.</p> <ul style="list-style-type: none"> • Move the unit down and align the tips to the center of the wells. Select Set ▷ to save this position. • Repeat at position B. 	-
Z Height	<p>Activate to enable overriding of the defined Z height. Keep pushing down the control unit to overcome the Z height, see “4.3.2 Set Z-Position” on page 25.</p>	<p>✓/* (On/Off)</p>

For pipetting in a 24 well plate, align the 24 channel head to the center of the wells. For tip loading with a 24 channel head and reformatting 24 to 96, head align according picture below:

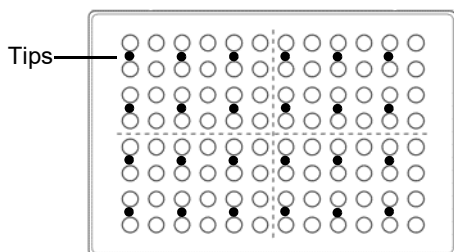

Plate holder for 24 channel head in **A**

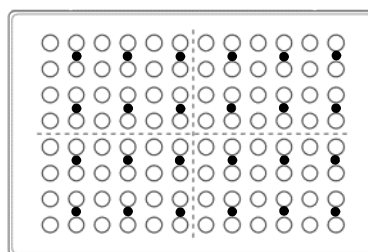

Plate holder for 24 channel head in **B**

3.4.4 Preferences

Preferences customizes your system parameters. Select an option and press **OK** to access. After changing desired settings, press **▷** to save.

Preferences	Description	Range
Deck Brightness	Sets brightness of deck illumination. • Use the touch wheel to change the brightness: off, 1 (weak) to 10 (bright). Press OK .	Off 1-10
Handle Sensitivity	Sets the sensitivity of the control unit to move the pipetting unit and base unit. • Use the touch wheel to set a sensitivity 1 (low) to 9 (high). Press OK .	1-9
Sound	Select an option and press OK to change the status of the beep tone between On and Off: • Step Complete : at the end of a program step • Program Complete : at program completion • Purge Key : when PURGE is pressed. • Messages : when a message appears. • Error Message : when an error message appears or when illegal data entry is attempted. • Touch Wheel : When spinning the touch wheel . • Last dispense : before the last dispense in Repeat Dispense and Variable Dispense.	✓/✖ (On/Off)
Display Brightness	Sets brightness of the display. Use the touch wheel to change the brightness: 1 (dim) to 10 (bright). Press OK .	1-10
Main Menu	Select a function to be hidden from the main menu (Off) and press OK : • Pipet, Repeat Dispense, Dilute, Pipet/Mix, etc. • The Automatic mode is by default deactivated. To activate it, change the status to “✓” (On). See section 5.3.3 for a description of the Automatic mode.	✓/✖ (On/Off)
Touch Wheel	Adjust your touch wheel spin sensitivity.	Low, Medium, High

Pipetting	<p>Select an option and press OK.</p> <ul style="list-style-type: none"> • Purge Key Speed: Choose the desired purge speed. • Blowin Delay: Choose a timed delay between the blowout and the blowin at the end of a dispense, if no two step blowout is performed, see “4.3.3 Blowout/blowin modes” on page 26. • Extend Volume (not available for 12.5 µl pipetting head): For pipetting below the volume range specified: 50 µl pipette: (1.0)–2–50 µl 125 µl pipette: (2.0)–5–125 µl 300 µl pipette: (5.0)–10–300–(310) µl 1250 µl pipette: (25)–50–1250 µl The volumes in brackets refer to extended volumes, e.g. extend the minimal pipetting volume of a 125 µl head from 5 µl to 2 µl. • Speed Table: Allows to define own pipetting speeds (µl/s) for speed steps 1-10 (see 7.5). Select a step, press OK and use the touch Wheel to change the value (µl/s). Press OK. • Pace in Custom: Allows for continuous dispensing by pressing and holding RUN during consecutive dispenses. To activate this feature, set the time gap between dispenses. 	<p>1-10</p> <p>None/ 0.5-5.0 s</p> <p>✓/✖ (On/Off)</p> <p>µl/s values depend on pipette size</p> <p>None/1-10 (slow-fast)</p>
-----------	---	---

**NOTE**

Extending the volume range is not recommended. Full functionality and specified accuracy/precision cannot be guaranteed.

Changing the speed table affects all programs running on the pipette. The default values (see [7.5](#)) are optimized for the pipette motor. Changing the values may cause a more noisy operation but does not harm the pipette.

3.4.5 Calibration & Services

These options enable you to set calibration features, review service history and move the pipetting head into the parking position.

Calibration & Services	Description	Range
Calibration	<p>Allows for re-calibration of VIAFLO 96/384 to restore accuracy. The calibration factors for Pipet and Repeat type are displayed.</p> <p>To edit the calibration volumes, press <Left>.</p> <ul style="list-style-type: none"> • Target Volume: This is the volume you are interested in using for the calibration. • Actual Volume: This is the measured volume obtained when dispensing the target volume. • Current Factor: Displays the factor currently in use. This factor should be the same as specified on the head or the latest calibration certificate. • <Left> Reset: Resets the correction factor back to the original factory setting. Press <Left> to apply the factory setting. 	-
Calibration Reminder	<p>Sets a calibration reminder based on a number of pipetting cycles. When the calibration reminder is displayed, press any key to confirm. However, the reminder will reappear every time the pipette is turned on until you change the reminder time or use the reset option.</p> <ul style="list-style-type: none"> • Reminder: Press OK to turn the reminder timer On or Off. • Cycles: Use the touch wheel to set a reminder interval for calibration (time in thousands of cycles). Press <Left> to set the timer to the defined calibration interval. • Remind in/Total Cycles: Displays the residual amount of cycles before calibration is required. • <Left> Reset: Resets the timer to the defined calibration interval. Press <Left> to enable. Press > to save. 	✓/* (On/Off) 1k - 240k cycles
X/Z Adjustment	<p>Allows to set a global offset in X and Z to the zero (home position). Only change these values when general positioning is shifted, and therefore incorrect, in an automatic program.</p>	-
Service History	<p>Displays notes of any service that took place on the VIAFLO 96/384 listed newest entry first.</p>	-

Park Head	Fixes the pipetting and base unit for safe transportation. • Make sure GRIPTIPS are ejected, clear the deck and press RUN to start the park routine. The pipette moves to park position and can then be turned off.	-
-----------	---	---

After changing desired settings, press ▷ to save.

3.4.6 Communications

VIAFLO 96/384 can be programmed from a PC via USB communication cable (type A to B).

Communi-cations	Description
VIALINK	Connect the USB cable between VIAFLO 96/384 (11) and a PC. Press OK to begin bi-directional communication. To exit the communications mode turn off VIAFLO 96/384.

3.4.7 Device Information

Device Information	Description
VIAFLO 96/384	Owner: Press ◀ to enter the user name for your pipette. Use the touch wheel to highlight a character and press OK . You can press ◀ to Delete the last character entered. After entering the desired text, press ▷ to save.

In addition, information about your VIAFLO 96/384, such as serial number, the firmware (FW) and hardware (HW) version of the control unit and of the base unit are displayed.

3.4.8 Language

Language	Description
Language	You can choose the language in which all screens are displayed. Scroll to the desired language, press OK and ▷ to save.

3.4.9 Write protect

Select this option to protect programs and menu options from inadvertent modification. The pipetting programs can still be used.

Write protect	Description	Range
	Select an option and press OK to switch protection on or off: <ul style="list-style-type: none"> • Standard Programs • Custom Programs • Calibration • Toolbox • Password Protection: Protect the access to the write protect menu by selecting “✓”. • Edit Password, if password protect is switched on. To enter a password use the touch wheel to highlight a character and press OK. Press ▷ to save the password. The password must be entered before you can access the write protect menu. 	✓/✖ (On/Off)

Keep the password in a safe place. Should you lose your password, contact INTEGRA Biosciences for assistance in retrieving it.

4 Operation

4.1 Turn on/off the device

Turn on:



CAUTION

Remove hands from **control unit** (5) at switch on and during homing.

When VIAFLO 96/384 is turned on by the **main switch** (10), you are prompted to press **RUN** (18) to perform a vertical and horizontal homing routine.

Press **RUN** again to home the pipetting unit. If filled tips are still on the device, put a basin below the pipetting head. After homing the Main menu is displayed.

Turn off:

To turn off VIAFLO 96/384, press the Main switch (10).



NOTE

VIAFLO 96/384 automatically goes into stand-by after 30 minutes of inactivity.

Press **OK** to continue.

4.2 Attaching and removing GRIPTIPS



CAUTION

To ensure optimal performance of your VIAFLO 96/384, use only GRIPTIPS designated for use with VIAFLO 96/384, see "8 Accessories and consumables" on page 60. To prevent contamination of VIAFLO 96/384 pipetting heads, it is recommended to use filtered GRIPTIPS only.



NOTE

When using 12.5 µl or 125 µl GRIPTIPS with a 96 channel pipetting head, put the tip rack on a **plate holder** with slide function and move the **plate slider** (9) to a 384 position, see "4.4.7 Pipetting between 24-96 and 96-384 well plates" on page 31.

When attaching tips with a 24 channel pipetting head, put the tip rack on the **plate holder** for 24 channel Pipetting head (Part No: 6222) and move the **plate slider** (9) to a 96 position.



NOTE

When a tip rack is stuck on the head, move the **pipetting unit** (3) up to the highest position. Hold the tip rack with both hands by the sides and gently pull the rack from the head. Avoid to place fingers between the rack and the **deck** (7) during this operation.

4.2.1 Loading tips from a complete rack

Put a tip rack either on the left or right **plate holder** (8). Hold the **control unit** (5) and lower the pipetting head down onto the tip rack until the **tip load button** (4) flashes.

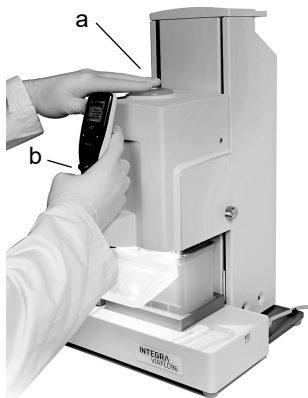

When prompted push the **tip load button** (a) and at the same time push down the **control unit** (b).

When the tips are loaded, the **tip load button** lights up. Move the **pipetting unit** (3) up until the light of the **tip load button** turns off.

4.2.2 Partial tip loading

Tip loading strength can be adjusted according to the number of tip columns being loaded in “low power” tip loading mode. This ensures that the tips can be correctly loaded, without damaging the tip rack.



CAUTION

The “low power” tip loading mode should be used when loading less than the full number of tip columns (less than 6 columns for a 24 channel head, less than 12 columns for a 96 channel head, less than 24 columns for a 384 channel head).

Put a tip rack either on the left or right **plate holder** (8). Hold the **control unit** (5) and lower the pipetting head down onto the tip rack until the **tip load button** (4) flashes.

When prompted to push the **tip load button**, first press **OK** (15) to switch to “low power” loading mode. If you want to change the number of columns to be loaded, press **OK** again and spin the **touch wheel** (14) to the desired amount. Confirm the value by pressing **OK**.



CAUTION

If you load tip rows instead of columns, multiply the number of rows by 1.5 and round up to the next higher number, e.g. enter “5” for 3 rows under number of columns.

By default, the loading strength is adjusted to load one column. If the amount of columns have been changed since the instrument was switched on, this amount will be used for tip loading by default in the “low power” loading mode.

Then push, as described above, the **tip load button** while pushing down the **control unit** until the **tip load button** lights up.

Move the **pipetting unit** (3) up until the light of the **tip load button** turns off.

4.2.3 Ejecting used GRIPTIPS

If liquid is in the tips, empty them by pressing the **PURGE button** (17). Tips are ejected by pressing the **tip ejector** (19). Confirm ejection by pressing the **tip ejector** a second time.

4.3 Start pipetting

4.3.1 Pipetting

Use the **touch wheel** (14) to scroll to your desired pipetting mode and press **OK** (15). Actions you are about to perform will be displayed on the Run screen.

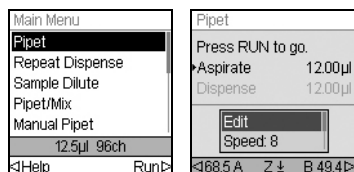

Insert the tips into the liquid to be transferred. Press and release **RUN** (18) to aspirate the volume selected in the first step of your protocol (shown on the Run screen).

To execute subsequent steps, press **RUN**.

For a detailed description of all pipetting modes see [“5.2 Detailed description of pipetting modes”](#) on page 35. You can change the parameters of your pipetting mode at any time, see the following sections.

4.3.2 Set Z-Position

To define the optimal tip immersion depth, press ◀ or ▶ to access the Z-position screen. Then move the pipetting unit to the target position (A, B) until the actual Z height and the current setting are displayed.

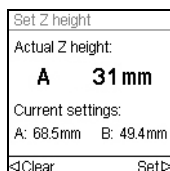

- Move the unit down to the desired dispensing height, e.g. 31 mm. Select ▶ Set to enter this position and save your setting.
- Repeat this procedure with position B.

4.3.3 Blowout/blowin modes

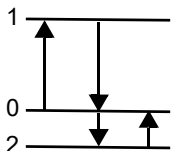

During aspiration, the piston of your electronic pipette moves up (1).

During dispensing, the piston returns to the initial position (0). During the last dispense of a program, it automatically moves further down (2) and blows the remaining liquid from the tip (Blowout↓).

When the piston returns to the initial position (0), a small amount of air is aspirated, provided the tip is no longer immersed in the liquid (Blowin↑).

There are two ways which the blowin occurs:

- **Manually controlled blowin** (recommended): Perform this routine to manually delay the blowin:
 - Press and hold **RUN** to start dispense with blowout.
 - Remove the tips from the target vessel.
 - Release **RUN** to start blowin.
- **Automatic blowin**: Pressing (and releasing) **RUN** starts the dispense with automatic blowout and blowin. You can choose a timed delay between the blowout and the blowin, see “Pipetting - Delayed blowin” under “3.4.4 Preferences” on page 18.

4.3.4 Recommendations for pipetting

INTEGRA Biosciences recommends the following techniques for enhancing pipetting results. These techniques are consistent with ISO standard 8655-2.

- It is best to immerse the GRIPTIPS just enough in liquid to allow the desired volume to be aspirated.
- Always pre-wet GRIPTIPS. After loading tips onto your pipette, aspirate and dispense the full volume 2-3 times to coat the inside of pipet tips. Pre-wetting ensures that the liquid and air inside the tips are at equal temperature and the dead air space is humidified.
- VIAFLO 96/384 is an air displacement pipette. It requires to touch the GRIPTIPS against the side of the well or dip them into the liquid after a dispense. This process is referred to as “touching off” or “tip touch” and prevents liquid from clinging to the pipette tips.
- In programs such as Repeat Dispense, a pre- and post-dispense can be programmed. These two dispenses are not used and are dispensed into the waste as they contain the accumulated pipetting errors. Using a pre- and post- dispense is recommended if accuracy and precision are of high importance.
- Viscous samples should be aspirated and dispensed at the slowest speeds to ensure accurate pipetting. In addition, the pipetting mode “Reverse pipet” can be used to optimize pipetting results with viscous samples.
- For pipetting liquids with high vapor pressures (such as methanol or ethanol), use relatively fast pipetting speeds and avoid prolonged pauses after aspiration.
- Calibrate based on fluid type. VIAFLO 96/384 is tested and calibrated at the factory for use with distilled water at room temperature. It may be necessary to re-calibrate your VIAFLO 96/384 if the liquid to be used has different physical properties (specific gravity and vapor pressure) than water. Calibration mode can be accessed in the Toolbox menu.
- VIAFLO 96/384 is not calibrated out of the factory below 10% of its maximum volume. While it is possible to pipette below 10% of the maximum volume, it may lead to an undesirable precision and accuracy result. Therefore, if accuracy and precision are critical, it is recommended to work above 10% of the pipette’s maximum volume.

**WARNING**

Avoid pipetting for extended periods. To minimize the risk of repetitive strain injury, include regular pauses of several minutes.

4.4 Pipetting options and settings

4.4.1 Edit option

The Edit option is available for each mode. It enables you to access the variables that you can adjust for a pipetting mode. These variables include Speed, Volume, Pace, Count, Mix Cycles, Rows and Direction. Additional steps include Pre-Dispense, Post-Dispense, Air Gap, Aspirate Speed, Dispense Speed, etc..

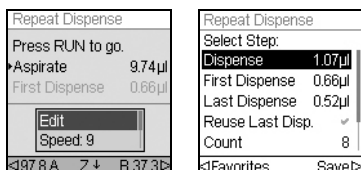

Select a pipetting mode. Then, select Edit on the list of options and press **OK**. A list of associated steps is displayed. For example, if selecting Edit on the Repeat Dispense screen, the modifiable steps associated with Repeat Dispense are displayed.

4.4.2 Volume selection

To change a volume select the Edit option and press **OK**. The adjustable volumes are displayed.

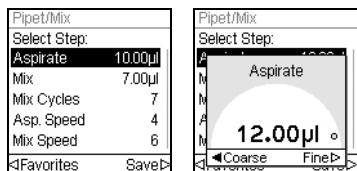

Use the **touch wheel** to highlight the volume you want to change (Aspirate, Dispense, Mix, or Air Gap).

Press **OK** and a Volume setting “dial” is displayed.

Use the **touch wheel** to change the volume. Press **OK** to confirm your volume selection and **▷** to save.



NOTE

Use the arrow buttons to change the volume in coarse or fine increments. Select **◀ Coarse** to change the volume in larger increments. Select **Fine ▶** to change the volume in smaller increments. The increment sizes vary based on the pipetting head, as shown under [“7.4 Pipetting specifications”](#) on [page 58](#).

Define and select favorite volumes

You can define, save, and select up to ten favorite volumes for quick access. These volumes can only be within the pipetting head volume range.

There are two ways to access and customize the list of favorite volumes:

- When in Pipet mode, use the **touch wheel** to highlight Favorites and press **OK**.
- When in other modes, select the Edit option and press **OK**. The steps with volumes to be adjusted are displayed. Use the **touch wheel** to highlight the desired volume and press **<** Favorites to display the list of favorite volumes.

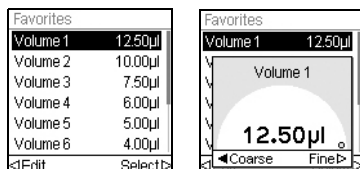

Use the **touch wheel** to highlight the desired volume and press **>** Select. Alternatively, modify a volume by pressing **<** Edit.

Save **>** your setting.

4.4.3 Speed selection

The speed option controls the speed at which liquid is aspirated, dispensed, or mixed in each mode. Speed can be set as a value from 1 (slowest) to 10 (fastest).

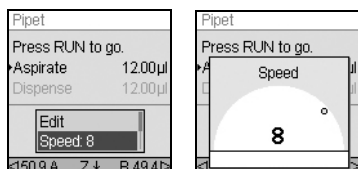

When in any pipetting mode, use the **touch wheel** to highlight the Speed option and press **OK**. Select the speed and press **OK** to save your setting.

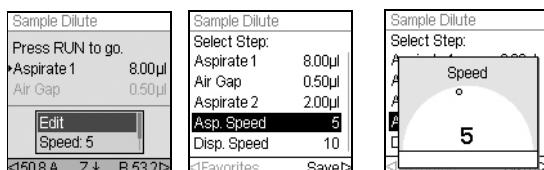

Speed may be changed in most Edit menus. Scroll to the Speed and press **OK**. Choose the speed, press **OK**, and press **>** to save your selection.

The speeds selected in each mode (i.e., Pipet, Repeat Dispense, etc.) are stored for that mode only.

Speeds can be set independently for each operation (Aspirate, Dispense, Mix).



NOTE

Viscous samples should be aspirated and dispensed at the slowest speeds to ensure accurate pipetting.

To dispense liquids with low viscosity and high vapor pressure, such as ethanol, use relative fast pipetting speeds and avoid prolonged pauses for aspiration.

4.4.4 Custom

You can convert any predefined pipetting mode into a Custom program.

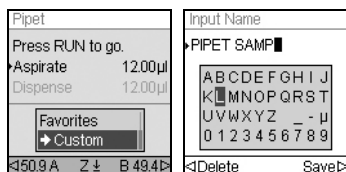

After setting up a pipetting mode with your parameters, use the **touch wheel** to select **►Custom**.

You are prompted to enter a name. Use the **touch wheel** to select characters and press **OK**. Once finished, press **►** to save the name.

The program is now stored in the Custom program section.

4.4.5 Pace

The Pace option sets the time gap between dispenses in repeat pipetting. Pace is used in the Repeat Dispense and Variable Dispense modes. While you press and hold **RUN**, the pipette will dispense multiple programmed volumes with the selected pace. Release **RUN** to stop the paced dispense. Press **RUN** to continue dispensing.

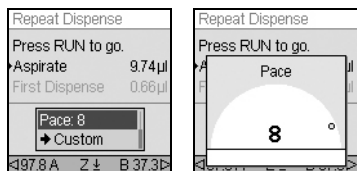

Use the **touch wheel** to select the desired Pace option and press **OK**.

Select the pace, from None, 1 (slowest) to 9 (fastest). Press **OK** to save your setting.

4.4.6 Count, Mix Cycle and Rows

The Count, Mix Cycle, and Rows steps are used in various modes, see [“5.2 Detailed description of pipetting modes”](#) on page 35. Each is accessed with the Edit option. Use the **touch wheel** to highlight the step and press **OK**.

Count sets the number of dispensing steps. Mix Cycle sets the number of mixes. In serial dilution mode, Rows sets the number of rows. A row indicator will notify the number of dilutions performed. Rows (first number) and Mix Cycles (second number) are tracked on the display. Mix Cycles are shown in red when mixing. A green dot on the row number indicates the active program step.

Select a desired value. Press **OK** and then press **►** to save your setting(s).

4.4.7 Pipetting between 24-96 and 96-384 well plates

For fast and simple reformatting between 96 and 384 well microplates and for loading of 12.5 or 125 µl GRIPTIPS with a 96 channel pipetting head, some **plate holders** feature a slide function to shift the microplate in Y-direction beneath the pipetting head. Put this **plate holder**, accommodating the 384 well plate, either on **position A** or **B** (8). Move the **plate slider** (9) to one of the following 3 positions:

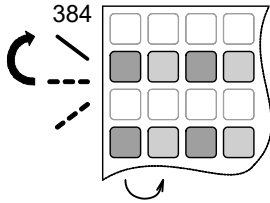

The back position of the **plate slider** is used to accommodate the front positions of 384 well plates.

For pipetting the second columns move the pipetting head one well to the right, or left respectively.

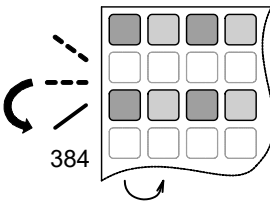

The front position of the **plate slider** accommodates the back positions of 384 well plates.

For pipetting the second columns move the pipetting head one well to the right, or left respectively.

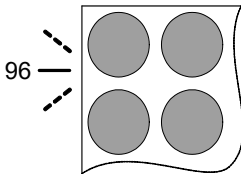

Set the **plate slider** to the middle to pipet 96 well plates.

24 channel pipetting head

Use the **plate holder** for 24 channel Pipetting head (Part No: 6222) to access the GRIPTIP rack with a 24 channel pipetting head and for pipetting between 24 and 96 well plates.

The same principle as above applies. The back position of the **plate slider** is used to accommodate the front positions of the 96 well plate (or tip rack). The front position of the **plate slider** accommodates the back positions.

Any INTEGRA **plate holder** can be used to access 24 well plates with the 24 channel pipetting head.

4.4.8 Pipetting with the three position stage

The three position stage (see “8.1 Accessories” on page 60) supports the pipetting on two of three possible positions.

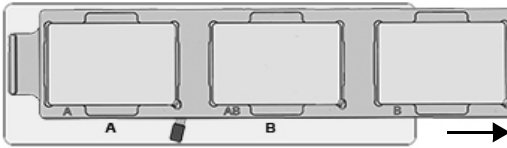

Move the three position stage to the right to pipette on position A and AB.

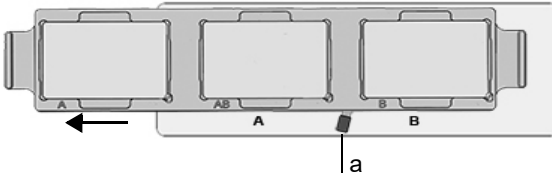

Move the three position stage to the left to pipette on position AB and B.

Use the **stage slider** (a) to accommodate the positions of 384 or 96 well plates as described in 4.4.7.

The three position stage cannot be used to pipette between 24 and 96 well plates.

4.5 Troubleshooting/FAQ

Problem	Probable cause	Remedy
Base unit is drifting sideways.	Control unit was touched at switch on.	Do not touch the control unit when switching on the VIAFLO 96/384. Restart VIAFLO 96/384 to initiate new homing routine.
Touch wheel does not work properly.	Control unit was touched during homing.	Do not touch the control unit during homing. Restart VIAFLO 96/384 to initiate new homing routine.
Menu options not selectable (grayed out).	No pipetting head installed.	Install a pipetting head.
Pipetting not possible.	Side cover missing or pipetting head not correctly installed.	Ensure pipetting head is installed correctly. Mount the side cover and screw the knob tightly.
Tips cannot be loaded.	Z height defined too high above the top of the rack.	Exit the pipetting mode. Alternatively clear Z height setting on position where tips are loaded.
Tips are not centered in the wells, although tip alignment is activated.	Head alignment was not performed yet.	Perform head alignment for every pipetting head.
Droplets on the tips.	Temperature of liquid differs from that of air inside the tips.	Pre-wet tips up to 3 times.
	Liquid of low viscosity and high vapor pressure.	Pre-wet tips and increase dispensing speed.
	Touch-off was not performed.	Perform a touch-off (mandatory in Repeat Dispense and Variable Dispense mode).
Obstruction error.	Base unit moved in X direction by hand.	Always hold the control unit to move the base unit sideways.
	Tips hit an obstacle during X movement, e.g. rack, container.	Move the tips upwards to a height that clears the tip rack out.
	Guide rail soiled.	Clean the guide rail for base unit.
	Other causes.	Switch the device off and on.

5 Pipetting modes

This chapter describes how to program the VIAFLO 96/384 in two ways:

- **Function-based pipetting modes:** You can select from ten predefined pipetting modes that you can quickly and easily edit and execute. They are described in the following sections.
- **Custom step-based programming mode:** You can create and store up to forty multi-stepped pipetting protocols on the pipette using the basic functions of “Aspirate, Dispense, Mix, Purge, Prompt, Set Z Height, Tip Align and Loop” presented in [“5.2 Detailed description of pipetting modes” on page 35](#). The custom programming mode is described in [“5.3 Custom step-based programming mode” on page 44](#)

5.1 Overview pipetting modes

The table below provides an overview of the selectable pipetting modes. All modes are accessed from the Main Menu. Use the **touch wheel** to scroll to your desired pipetting mode.

Pipetting mode	Description
Pipet	Allows liquid transfers when aspirate and dispense volumes are equal.
Repeat Dispense	Allows dispensing multiple aliquots of the same volume without refilling the tips after each dispense for fast microplate filling and processing.
Sample Dilute	Allows aspirating of sample and diluent divided by a defined air gap into one tip, followed by a complete dispense.
Pipet/Mix	Transfers a defined volume and follows with a defined number of automatic mixing cycles.
Manual Pipet	Allows the operator to manually control the aspiration and dispensing up to the set volume.
Reverse Pipet	Allows liquid transfers of viscous or high vapor pressure liquids by preventing introduction of any air into the sample. The aspiration volume is higher than the volume to be dispensed.
Variable Dispense	Allows dispensing multiple aliquots of different volumes.
Multi Aspirate	Allows aspirating multiple aliquots of different volumes.
Sample Dilute/Mix	Allows aspirating two liquids separated by an air gap followed by a complete dispense and Mix step.
Serial Dilution	Allows aspirating a transfer volume followed by a mix. Rows and Mix Cycles are tracked on the display.
Custom	Allows to create and store of up to 40 multi-stepped pipetting protocols.

Press the **OK** to access the pipetting mode and to start defining parameters. Press **<** to select the Help option.

5.2 Detailed description of pipetting modes

VIAFLO 96/384 offers ten predefined pipetting modes. Most liquid handling protocols can be easily accommodated using one or more of these modes. The options and steps of the different pipetting modes are described in the following subsections.

5.2.1 Pipet mode

Application: Use this mode for quick transfer of liquid to or from microplates.

Options	Steps	Description
Edit	Aspirate	Sets the aspiration volume that is equal to the dispense volume.
Speed		Sets speed for the current pipetting step (1 = low, 10 = fast).
Favorites		Defines up to 10 favorite volumes
Custom		Converts the predefined program into a custom program.

Operation:

- With the tip(s) in liquid, press and release **RUN** to aspirate.
- With the tip(s) in the destination plate, press and hold **RUN** to execute the dispense and perform a two-step blowout, see [“4.3.3 Blowout/blowin modes”](#) on page 26.
- When the tips are removed from the target plate, release **RUN**.

5.2.2 Repeat dispense mode

Application: This mode can be used for fast reagent addition to microplates from one source container. You can dispense a large aspirated volume of liquid in multiple aliquots to multiple targets.

Options	Steps	Description
Edit	Dispense	Sets the volume for repetitive dispensing. The aspirated volume is calculated automatically.
	Count	The maximum number of dispenses possible (count) is calculated automatically. This count may be reduced to the desired number.
	Pre-Dispense	A pre-dispense volume (typically 3-5% of the pipette's maximum volume) can be selected independently to improve accuracy and precision. The dispense is discarded.
	Post-Dispense	A post-dispense volume (typically 3-5% of the pipette's maximum volume) can be selected independently to improve accuracy and precision. The dispense is discarded.
	Reuse Post-Disp.	By default (red ✖), the mode ends with dispensing of the post dispense. This aliquot contains the accumulated error from all prior dispenses. If you want to reuse the post dispense, press OK (green ✓). At the end of the program the post dispense remains in the tip, while the pipette is ready to aspirate a new volume to start the next repeat dispense run.
	Asp. Speed	Sets speed uniquely for aspirating (1 = slow, 10 = fast).
	Disp. Speed	Sets speed uniquely for dispensing (1 = slow, 10 = fast).
Speed		Sets speed of the current pipetting step.
Pace		Sets the time duration between dispenses in repeat pipetting, if keeping RUN pressed (1 = long, 9 = short).
Custom		Converts the predefined program into a custom program.

Operation:

- With the tip(s) in liquid, press and release **RUN** to initiate the aspirate step.
- Press and release **RUN** for every dispense. Alternatively, press and hold **RUN** to execute paced dispenses. The dispense number is shown on the display.
- The pipette will stop paced dispenses when it reaches the Last Dispense. You can choose to use this Last Dispense or discard it.
 - If reuse of last dispense is not activated, press and hold **RUN** to purge the Last Dispense volume with a two-step blowout.
 - If reuse of last dispense is active, you can start the next repeat dispense cycle with aspirating liquid to the last dispense in the tip. To finish the repeat dispense cycle, press **PURGE**.

5.2.3 Sample dilute mode

Application: Accomplish accurate sample dilutions by using diluent to “chase” small sample volumes from the pipet tips. An air gap keeps liquid separated in the tips and helps to minimize carryover of diluent when aspirating the sample.

Options	Steps	Description
Edit	Aspirate 1	Sets the volume of the diluent aspirated first in the tip.
	Air Gap	Sets the volume of the air gap to keep both liquids separated.
	Aspirate 2	Sets the volume of the sample in the tip.
	Asp. Speed	Sets speed uniquely for aspirating (1 = slow, 10 = fast).
	Disp. Speed	Sets speed uniquely for dispensing (1 = slow, 10 = fast).
Speed		Sets speed of the current pipetting step.
Custom		Converts the predefined program into a custom program.

Operation:

- Press and release **RUN** to initiate each aspiration (remove tips from liquid for air-gap aspiration).
- Press and hold **RUN** to perform a two-step blowout. The entire tip contents will be dispensed together.

5.2.4 Pipet/mix mode

Application: Use this mode when mixing is required immediately after transfer of liquid. This mode saves a programming step by incorporating the mix option after dispensing.

Options	Steps	Description
Edit	Aspirate	Sets the aspiration volume that is equal to the dispense volume.
	Mix	Sets the mixing volume after dispensing.
	Mix Cycles	Sets the number of mix cycles.
	Asp. Speed	Sets speed uniquely for aspirating (1 = slow, 10 = fast).
	Mix Speed	Sets speed uniquely for mixing (1 = slow, 10 = fast).
Speed		Sets speed of the current pipetting step.
Custom		Converts the predefined program into a custom program.

Operation:

- Press and release **RUN** to initiate the aspiration.
- Press and release **RUN** to dispense. Mixing occurs automatically after the dispense step.
- Upon completing the desired number of mixes, a blowout is initiated automatically prompting you to remove the tip(s) from the liquid and press **RUN** to complete the blowout.

5.2.5 Manual pipet mode

Application: This mode can be used when the aspiration volume is not defined or unknown. You have control over the aspiration and dispense steps and can view the display to confirm how much liquid has been aspirated or dispensed. Manual control over the dispense steps is perfect for performing titrations or for controlling the loading of samples in gel lanes.

Options	Steps	Description
Edit	Aspirate	Sets the aspiration or dispensing volume. Toggle between Aspirate and Dispense using the Direction menu option.
Speed		Sets speed of the current pipetting step (1 = slow, 10 = fast).
Direction		Changes the direction of pipetting between aspiration (Δ) and dispensing (∇).
Favorites		Defines up to 10 favorite volumes

Operation:

- When aspirating, the motor will stop when you release **RUN** or when the programmed aspirate volume is reached.
- You can change pipetting direction at any time even if aspiration volume is not reached. Change the direction of pipetting by pressing **OK** on the Direction option. The notation on the display changes between Δ (Aspirate) and ∇ (Dispense).
- The volume remaining in the tip(s) is displayed.



NOTE

Use slower pipetting speeds (1-5) for better control and resolution.

5.2.6 Reverse pipet mode

Application: With this mode the aspiration volume is higher than the volume dispensed. It is recommended for liquid transfers of viscous and high vapor pressure liquids. The dispense method prevents introduction of air into the sample because no blowout is made.

Options	Steps	Description
Edit	Dispense	Sets the dispense volume.
	Post-Dispense	Sets the volume to leave in the tip until final blowout.
	Reuse Post-Disp.	By (red ✖) default, the mode ends with dispensing of the last dispense. If you want to reuse the last dispense, press OK (green ✓). At the end of the program the last dispense remains in the tip, while the pipette is ready to aspirate a new volume to start the next reverse pipet run.
	Asp. Speed	Sets speed uniquely for aspirating (1 = slow, 10 = fast).
	Disp. Speed	Sets speed uniquely for dispensing (1 = slow, 10 = fast).
Speed		Sets speed of the current pipetting step.
Custom		Converts the predefined program into a custom program.

Operation:

- Press and release **RUN** to initiate the aspiration. The total volume aspirated is the sum of desired dispense volume and last dispense volume.
- Press and release **RUN** to dispense the programmed volume.
- If reuse of last dispense is not activated, press and hold **RUN** to purge the Last Dispense volume with a two-step blowout.
- If reuse of last dispense is active, you can start the next reverse pipet cycle with aspirating liquid to the last dispense in the tip. To finish the reverse pipet cycle, press **PURGE**.

5.2.7 Variable dispense mode

Application: Use this mode when differing dispense volumes are required. This mode could be used to quickly set up a dilution series in plates or for feeding similar samples to different assay plates where different sample volumes are needed.

Options	Steps	Description
Edit	Count	Sets the total number of dispensing steps.
	Dispense 1...Count	Sets different volumes for repeated dispensing. Number of dispenses and dispense volume cannot exceed nominal volume of the pipetting head. The total volume is automatically calculated.
	Pre-Dispense	A pre-dispense volume can be selected independently to improve accuracy and precision. The dispense is discarded.
	Post-Dispense	A post-dispense volume can be selected independently to improve accuracy and precision. The dispense is discarded.
	Asp. Speed	Sets speed uniquely for aspirating (1 = slow, 10 = fast).
	Disp. Speed	Sets speed uniquely for dispensing (1 = slow, 10 = fast).
Speed		Sets speed of the current pipetting step.
Pace		Sets the time interval between dispenses, if keeping RUN pressed (1 = long, 9 = short).
Custom		Converts the predefined program into a custom program.

Operation:

- Press and release **RUN** to initiate the aspiration of total volume.
- Press and release **RUN** to initiate each subsequent dispense. The pipette stops and beeps when ready for the Last Dispense step, i.e. to purge the calculated waste volume amount.
- Alternatively, **press and hold RUN** to execute paced dispenses. The pipette stops paced dispensing when it reaches the Last Dispense. This aliquot contains the accumulated error from all prior dispenses. You can choose to use this Last Dispense or discard it.
- During the Last dispense, press and hold **RUN** to perform a two-step blowout.

5.2.8 Multi aspirate mode

Application: This mode can be used for a variety of collection applications where the aspiration volume is well known. This mode is also suited for supernatant collection in microplates.

Options	Steps	Description
Edit	Count	Sets the total number of aspirating steps.
	Aspirate 1...Count	Sets different volumes used for sequentially aspirating (in the same tip) followed by a single dispense. Number of aspirates and aspirate volume cannot exceed nominal volume of the pipetting head.
	Asp. Speed	Sets speed uniquely for aspirating (1 = slow, 10 = fast).
	Disp. Speed	Sets speed uniquely for dispensing (1 = slow, 10 = fast).
Speed		Sets speed of the current pipetting step.
Custom		Converts the predefined program into a custom program.

Operation:

- With the tip(s) in liquid, press and release **RUN** to initiate the first aspiration volume. Again in liquid, press and release **RUN** to initiate the second aspiration volume, etc.
- **Press and hold RUN** to start Dispense and perform a two-step blowout.

5.2.9 Sample dilute/mix mode

Application: Use this mode to perform sample dilutions where mixing of sample and diluent is required. This mode could also be used to introduce and mix diluent and sample to the first column of a serial dilution plate.

Options	Steps	Description
Edit	Aspirate 1	Sets the volume of the sample aspirated first in the tip.
	Air Gap	Sets the volume of the air gap to keep both liquids separated.
	Aspirate 2	Sets the volume of the diluent in the tip.
	Mix	Sets the mixing volume after dispensing.
	Mix Cycles	Sets the number of mix cycles.
	Asp. Speed	Sets speed uniquely for aspirating (1 = slow, 10 = fast).
	Mix Speed	Sets speed uniquely for mixing (1 = slow, 10 = fast).
Speed		Sets speed of the current pipetting step.
Custom		Converts the predefined program into a custom program.

Operation:

- With the tip(s) in liquid, press and release **RUN** to initiate aspiration 1. With the tip(s) out of the liquid, press and release **RUN** for the Air Gap. Again in liquid, press and release **RUN** to initiate aspiration 2.
- Press and release **RUN** to dispense the entire tip contents and begin the mixing routine. Upon completing the desired number of mixes, a blowout occurs automatically. Remove tips from liquid and press and release **RUN** to complete the blowout.

5.2.10 Serial dilution mode

Application: Use this mode to perform serial dilutions. The Serial Dilution mode enables aspiration of a specific volume followed by a mix sequence and ending with the original aspiration volume in the tips.

Options	Steps	Description
Edit	Aspirate	Sets the aspiration volume that is identical to the dispense volume.
	Mix	Sets the mixing volume after dispensing.
	Mix Cycles	Sets the number of mix cycles.
	Rows	Sets the number of rows. A row indicator will notify the number of dilutions performed.
	Asp. Speed	Sets speed uniquely for aspirating (1 = slow, 10 = fast).
	Mix Speed	Sets speed uniquely for mixing (1 = slow, 10 = fast).
	Disp. Speed	Sets speed uniquely for dispensing (1 = slow, 10 = fast).
Speed		Sets speed of the current pipetting step.
Custom		Converts the predefined program into a custom program.



NOTE

For serial dilutions it is helpful to switch Column Detent on, see “Tip Align” under “Position Settings” on page 17.

Operation:

- Attach 4, 8, or 16 GRIPTIPS on the leftmost row by lowering the **pipetting unit** onto the tips.



CAUTION

When prompted to push the **tip load button**, first press **OK (15)** to switch to “low power” loading mode. Then press the **tip load button** and at the same time push down the **control unit** to load the tips with reduced forces.

- Replace the tip rack with the microplate and put the reagent container on the other position, e. g. position A. Press and release **RUN** to initiate the aspiration of the reagent.
- Press and release **RUN** to start the dispense and mix sequence. Proceed with the next rows.
- Rows (first number) and Mix Cycles (second number) are tracked on the display. Mix Cycles are shown in red when mixing. A green dot on the column number indicates the active program step.

5.3 Custom step-based programming mode

Application: Use the Custom program mode to create personalized pipetting protocols. Up to forty programs can be stored.

Select “Custom” to create a personalized protocol. Programs can contain up to 98 individual steps based upon the following basic operations: Aspirate, Dispense, Mix, Purge, Prompt, Set Z Height, Tip Align and Loop.

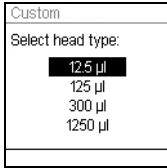
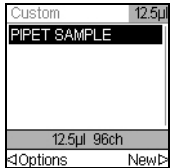

Press **▷** to create a new program. Select the pipetting head and the type of the new custom program, i. e. Manual or Automatic.



NOTE

The program type can only be selected if “Automatic” is activated under Toolbox - Preferences - Main Menu, see “3.4.4 Preferences” on page 18. We recommend creating automatic custom programs on a PC with the VIALINK software, see also “5.4 VIALINK” on page 50.

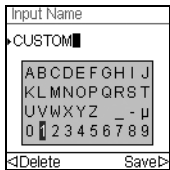

Next, you are prompted to enter a name.

Use the **touch wheel** to select characters and press **OK**. Once finished, press **▷** to save the name.

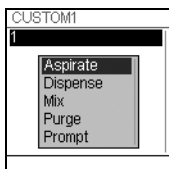
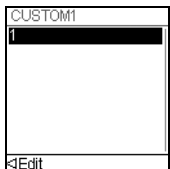

The first step is highlighted, press **OK**.

Use the **touch wheel** to select the first step from the menu, e. g. Aspirate. Press **OK**. Define the required parameters and press **OK** to add the step.

After adding the first step, the selection should now be on the second line. Press **OK** again to define the second step. Continue adding steps until your entire pipetting protocol is defined.

5.3.1 Manual custom program

Manual custom programs can consist of the following steps:

Step	Description
Aspirate	Sets an aspiration volume and speed.
Dispense	Sets a dispense volume and speed.
Disp. NBO (No BlowOut)	Sets the volume and speed for a dispense without blowout. Residual liquid may remain in the tip, resulting in inaccurate and imprecise liquid delivery. Select this step only if accuracy and precision are not important.
Mix	Sets the mixing volume after dispensing.
Mix NBO (No BlowOut)	Sets the mixing volume and speed without a blowout after the last dispense. Residual liquid may remain in the tip, resulting in incomplete mixing and inaccurate and imprecise liquid delivery. Select this step only if introduction of air into the sample must be prevented.
Purge	Purges all remaining liquid currently in the GRIPTIPS with the selected purge speed. A "Purge" step is automatically integrated at the end of a program if the last programming step leaves liquid in the tips.
Prompt	A prompt is any message that is displayed during the program. Three lines with a total of 30 characters are available. To continue the program, press RUN .
Timer	Sets a timer from 0 s to 60 min. When the count down is finished, the next step is performed automatically. If under Preferences - Sounds the option Messages is set to On a beep tone sounds.
BlowOut	Performs a blowout. A blowout needs to be performed after the last dispense to expel residual liquid. Note: When using a standard "Dispense" step or "Purge", a blowout/blowin is performed automatically to empty the tips and does not need to be programmed.
Blowin	If a BlowOut step was added, it needs to be followed directly with a BlowIn. It brings the piston(s) back to the home position. Make sure to remove the tips from the liquid before starting the BlowIn.
Z Height	Sets the Z height on Position A or B .
Loop	A loop repeats the steps between the selected step and the loop command. Chose to which step the loop directs and how many times the loop should be performed. The number of steps can often be shortened by adding a loop. Note: Nested loops (loops inside loops) are not allowed.

Step	Description
Beep	Sets a beep. The sound is only active, if under Preferences - Sounds the option Messages is set to On.
Tip Align	Within a custom program, you can switch the tip alignment on or off, if required. Use the touch wheel to select Tip Align and press OK . Select Position A or B and press OK to toggle between „✓“ (On) and „✖“ (Off), see also “3.4.4 Preferences” on page 18 . The tip align setting applies to the subsequent steps of the custom program.

When starting with an “Aspirate” step followed by a “Mix” step, the tips contain the aspirate volume after completing the last mix cycle. When starting with a “Mix” step, the tips are emptied upon completion of the last mixing cycle.

To save and store a Custom program, press Save ▷.

Example of manual custom program

The task is to combine 2 different liquids in a 96 well plate for a kinetic assay and then mixing it to achieve a homogeneous solution. The microplate should then be incubated for 5 minutes and the content is then distributed to a 384 well plate. The custom program would be set up as followed:

Program step	Action
1) Aspirate liquid 1: 160 µl (e.g. diluent)	With tips in liquid 1 press RUN .
2) Aspirate air: 20 µl	Move tips out of liquid and press RUN .
3) Aspirate liquid 2: 50 µl (e.g. reagent)	With the tips in liquid 2 press RUN .
4) Dispense: 230 µl	Press and hold RUN until liquid is dispensed and tips are removed from the liquid (two-step blowout).
5) Mix 3x: 200 µl	Press RUN .
6) Prompt: Incubate 5 min	No action.
7) Aspirate: 210 µl	With tips in the 96 well plate, press RUN .
8) Dispense: 50 µl	Move the plate slider to the front and press RUN to dispense the back positions of the 384 well plate.
9) Dispense: 50 µl	Move the pipetting head one well to the right and press RUN to dispense the second columns.
10) Dispense: 50 µl	Move the plate slider to the back and press RUN to dispense the front positions of the 384 well plate.
11) Dispense: 50 µl	Move the pipetting head to the left and press RUN to dispense the first columns.
12) Purge	Purge (does not need to be programmed). The residual liquid is dispensed into the waste container. Press and hold RUN until liquid is purged and tips are removed from the liquid (two-step blowout), see “4.3.3 Blowout/blowin modes” on page 26.

**NOTE**

The program steps 8-11 can be shortened with the Loop step:

9) Loop to step 8, 4 times

10) Purge

5.3.2 Modify existing programs

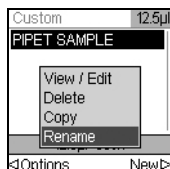

At the Custom program display, use the **touch wheel** to highlight an existing program. Press \triangleleft Options, use the **touch wheel** to select an option (View/Edit, Delete, Copy, Rename) to modify the program and press **OK**.

Press **back** to return to the list of Custom programs. To run the program, press **OK**.

5.3.3 Automatic custom program

The Automatic Mode performs automatically a defined series of liquid handling operations. This mode is by default inactive and has to be manually enabled, see “3.4.4 Preferences” on page 18.

An automatic Program always starts with a Move X,Z step to define the starting position.

Step	Description
Move X,Z	Moves the pipetting head to new X/Z-position in mm of the selected coordinates (up-most position first) ¹ . Move the pipetting head to the desired position and press Set \triangleright to adapt the Current Setting to the momentary position.
Move Z	Move the pipetting head to the desired position and press OK to adapt the Current Setting to the Actual Position. The pipetting unit moves to the defined absolute Z height.
Move X	This command travels the set distance in X-direction relative to the actual position. Setting a negative value (mm) moves the unit to the left, setting a positive value (mm) moves the unit to the right. Use the touch wheel to enter the desired value and press OK .

1. In a Move X,Z step, if the pipetting head is above the next X,Z coordinate before moving, it will first move sideways in the X-Axis to the programmed coordinate, and the second move is down in the Z-Axis. If the head is below the selected X,Z coordinate, it will first move upwards.



CAUTION

Always ensure that the pipetting head is at a clear height for a movement to the side.

Step	Description
Blowout / Blowin	<p>In automatic mode, the blowout and blowin need to be programmed after the last dispense.</p> <p>After a blowout, a blowin has to follow at some point. It does not have to follow immediately and can have steps in between. E.g. after the blowout a move step can be programmed to move the tips out of the liquid, and is then followed by the blowin.</p> <p>Note: When using “Purge” to empty the tips, a blowout/blowin is performed automatically and does not need to be programmed.</p>
Delay	<p>A delay is a pause between the last and the next step, and can be set from 0.1 - 10 seconds.</p> <p>If it is set to 0.0 s, pressing RUN is required to trigger the next step.</p>
Loop	<p>A loop repeats the steps between the selected step and the loop command.</p> <p>Chose to which step the loop directs and how many times the loop should be performed.</p> <p>The number of steps can often be shortened by adding a loop.</p> <p>Note: Nested loops (loops inside loops) are not allowed.</p>
Tip Change	<p>Pauses the program. The user is prompted to eject and load tips manually. The program continues with the next step after pressing RUN.</p>
Beep	<p>Sets a beep. The sound is only active, if under Preferences - Sounds the option Messages is set to On.</p>

As manual custom programs, automatic programs can be created directly on VIAFLO 96/384. However, we recommend using the VIALINK software to set up automatic custom programs, see [“5.4 VIALINK” on page 50](#).

Example of automatic custom program

The task is to perform a serial dilution over the entire 96 well plate. The concentrated sample is in column 1. The custom program would be set up as followed (note that position values might slightly differ when adapting the protocol on a different unit):

Program step	Action
1) Move X,Z ¹ : X -16.6 mm, Z 30,1 mm	Sets the start position to aspirate the sample in the first column.
2) Aspirate liquid: 100 µl	The concentrated sample is aspirated.
3) Mix: 2x 100 µl	The sample is re-suspended during mixing. The aspiration volume of 100 µl remains in the tips after mixing.
4) Move Z: 40.8 mm	The pipetting head moves upwards.

5) Move X: 9.0 mm	The pipetting head moves to the next column on the right.
6) Move Z: 30.0 mm	The pipetting head moves down into the well.
7) Mix 3x: 150 µl	During mixing the sample is diluted, 100 µl remain in the tips after mixing.
8) Loop: Step 5, Count 11	Continue serial dilution in the next wells (repeats steps 5-8 eleven times).
9) Move Z: 80.7 mm	The pipetting head moves upwards.
10) Move X,Z: X -75.8 mm, Z 52.6 mm	The pipetting head moves to the waste container.
11) Purge: Speed 8	The residual liquid is dispensed into the waste container.

1. There should be no obstruction in the X-Axis before starting an automatic custom program.

**NOTE**

GRIPTIPS cannot be attached automatically.

5.4 VIALINK

VIALINK is a pipette management software for the PC and is used to manage VIAFLO 96/384 and VIAFLO electronic hand held pipettes. It allows to create custom programs, manage a library of custom programs, establish a service history and more.

To establish a connection between computer and VIAFLO 96/384, a standard USB cable (type A to B) is required.

The software VIALINK can be downloaded from the INTEGRA website in the product section and is free of charge for all VIAFLO 96/384 customers. A detailed description of the software, along with the operating instructions, can be found on the website as well.

6 Maintenance

6.1 Cleaning and Decontamination

**WARNING**

Always turn off power and disconnect the VIAFLO 96/384 from the mains when carrying out maintenance work.

6.1.1 Cleaning

If the external components of the base unit get soiled, clean them with a lint-free cloth lightly soaked with mild soap solution in distilled water or with a 70 % dilution of Isopropyl or Ethanol. Never use acetone or other solvents. Ensure that the guide rails of the base unit are clean, greasing is not required.

Remove the pipetting head from the device. Regularly clean the pipetting head surface and the tip fittings with a moist lint-free cloth lightly soaked in distilled water or Ethanol/ Isopropyl 70 %. Alternatively, just spray Ethanol 70% or Isopropyl 70% on the tip fittings and let them dry. Do not spray into the tip fittings.

**WARNING**

Spraying Ethanol 70% or Isopropyl 70% on the tip fittings may not be sufficient to completely decontaminate the pipetting heads because it does not reach the inner parts. Only gas sterilization or autoclaving inactivates harmful micro-organisms on the inner parts of the pipetting heads.

6.1.2 Decontamination

If the surfaces of the VIAFLO 96/384 have been in contact with biohazardous material, they must be decontaminated in accordance to good laboratory practice. Wipe the clean surface with a lint-free cloth, lightly soaked with a disinfectant. For example:

- Ethanol 70 %
- Microcide SQ 1:64
- Glutaraldehyde solution 4 %
- Virkon solution 1-3%

Follow the instructions provided with the reagents.

The device and the pipetting heads may be decontaminated with H₂O₂ gas (maximal concentration 35 %) for 60 minutes.

6.2 Prolonged period of non-use

Pipetting heads of VIAFLO 96/384 should not be left inside the device if not used for extended periods (>1 week). Remove the pipetting head from the device and store it wrapped in a plastic bag in the appropriate casing.

6.3 Leak test

It is recommended to perform a leak test every 3 months or when errors occur.

Leak test may be done on half of the head at a time or column by column for a better view of the liquid levels (load one GRIPTIP column with reduced force as described under operation of "[4.2.2 Partial tip loading](#)" on [page 24](#)).

- 1) Choose Pipet/Mix mode and enter the following settings: aspirate the full volume at speed 6, mix cycles 6 at speed 6.
- 2) Fill a reservoir with distilled water (add some food coloring for better visibility).
- 3) Pre-wet the GRIPTIPS: Start the Pipet/Mix program by pressing **RUN** (18). After aspiration, press **PURGE** (17) and confirm with **RUN**. This empties the tips. Repeat 2 more times to a total of 3 pre-wet cycles.
- 4) Press **RUN** again to aspirate. Leave the tips immersed 2-3 mm in the liquid and observe for 30 s the liquid levels in the tips. During this wait time the liquid levels must not decrease.
- 5) Press **RUN** again to start the mix cycles.
 - a) Observe whether air bubbles are forming at the tip ends when dispensing.
 - b) Check whether the levels stay approximately the same across all channels.
 - c) At the end of a last dispense it is normal to have air bubbles because a blowout is performed.

If in doubt about a particular channel, load a tip on this channel only and repeat the test.

Signs indicating a leak

- 1) Liquid level in one or more tips is decreasing while the tips are immersed in liquid during the 30 s wait time.
- 2) During the mix cycle the top aspiration level in one or more tips is gradually decreasing. This shows in uneven liquid levels across the tips after aspiration.
- 3) One or more tips show air bubbles at the tip end during the mix cycles.



NOTE

A decreasing liquid level at aspiration could be an indication of a slow leak. Performing a retest at 10 mixes may help identify a slow leak.

If a leaking channel is identified, change the colored O-ring on that specific tip fitting (where applicable, see [6.4.2](#)) or contact your service technician.

6.4 Servicing

An annual maintenance service is required on the VIAFLO 96/384 base unit as well as calibration of all pipetting heads in order to ensure optimal pipetting accuracy/precision, as well as a long life for the instrument. In addition, a complete pipetting head refurbishment must be performed every 2-3 years to ensure proper function and longevity of the head.

Please contact INTEGRA for more details and pricing information.



WARNING

If liquid ever enters the internals of VIAFLO 96/384 of the pipetting heads, please contact your service technician.

Pipetting heads need to be serviced by INTEGRA in the following cases:

- Liquid has entered the pipetting head
- The pipetting head had to be autoclaved for decontamination
- One or more channels did not pass the leak test
- The pipetting head was damaged



WARNING

If working with infectious materials, e. g. human pathogens, the pipetting heads need to be gas sterilized or autoclaved to decontaminate before sending them to service. The declaration on the absence of health hazards must be signed to confirm that the equipment has not been exposed to biohazards or radioactive materials and was appropriately decontaminated. This is necessary to protect service personnel.

6.4.1 Blocked pipetting unit

If the control unit is defect or the pipetting unit parks in down position and the pipetting head can not be removed, start the following procedure:

- 1) Turn off the VIAFLO 96/384. Turn it back on while pressing the **tip load button** (4) for approx. 5 sec. until the **tip load button** lights up permanently.
- 2) Release the **tip load button**. The button flashes, the pipetting unit moves up and the removal of the pipetting head will be enabled. (Ignore any display messages on the control unit.)
- 3) As soon as the button lights permanently, you can remove the pipetting head.
- 4) Press the **tip load button** for approx. 5 sec. until the button flashes. The pipetting unit moves into the park position.
- 5) When the light of the **tip load button** is off, turn off the VIAFLO 96/384.

6.4.2 Changing O-rings of tip fittings

300 µl and 1250 µl pipetting heads feature tip fittings with colored O-rings to seal against the inside wall of GRIPTIPS providing optimal sealing. O-rings are made of durable silicone.

If necessary, e.g. in case of a leakage due to damaged O-rings, you can replace these O-rings. A set of spare O-rings and an O-ring removal tool are included with each 300 µl and 1250 µl pipetting head, but can also be ordered separately, see 8.



WARNING

Avoid mechanical damage of the tip fittings.



Choose the side of the O-ring removal tool corresponding to the size of the pipetting head (300 µl or 1250 µl).



Place the O-ring removal tool vertically between the tip fittings (do not tilt).

Slide the O-Ring removal tool forwards until the O-ring (a) builds a loop. Cut the O-ring with fine scissors and remove it.

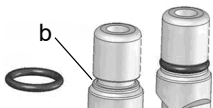

Slide a new O-ring over the tip fitting (b).

6.5 Calibration

VIAFLO 96/384 can be calibrated by adjusting a correction factor in the software. The correction factor is determined by a nominal volume and the measured volume. To assess the accuracy and precision of VIAFLO 96/384 pipetting heads, different methods can be used:

- Recommended: Measure one or more channels gravimetrically, followed by all other channels by photometry. Compare the photometrically determined channels relative to the gravimetrically measured channels.
- Gravimetric only.

INTEGRA Biosciences offers a calibration service for VIAFLO 96/384 pipetting heads performed according to the above mentioned recommended method. Please contact INTEGRA or your local dealer for more information.

6.6 Equipment disposal



The VIAFLO 96/384 must not be disposed of with unsorted municipal waste.

Dispose the VIAFLO 96/384 in accordance with the laws and regulations in your area governing disposal of devices. In certain regions and countries, e.g. in EU member states, the distributor is obliged to take back this product free of charge at the end of life. Please contact your local distributor for more details.

7 Technical data

7.1 Environmental conditions

	Operation
Temperature range	5–40 °C
Humidity range	Max. rel. humidity 80 % for temperatures up to 31 °C, decreasing linearly to 50 % rel. humidity at 40 °C.
Altitude range	< 2000 m

7.2 Specification of the device

Dimensions (W x D x H)	42 cm x 30 cm x 54 cm (17" x 12" x 21")
Weight of VIAFLO 96 incl. pipetting head	25.7 kg (56.7 lbs)
Weight of VIAFLO 384 incl. pipetting head	27.7 kg (61.1 lbs)
Electricity supply	Device input: 100–240 VAC, 50/60 Hz, 400 W
Pipetting channels of VIAFLO 96	24, 96, individual
Pipetting channels of VIAFLO 384	24, 96, 384, individual
Pipetting speed	10 steps
Compatible plate formats	24, 96, 384, and 1536 wells, shallow and deep well
Plate positions	up to 3
Pipetting technology	Air displacement
User interface	Touch wheel, color display

7.3 Intellectual property

For patent and trademark information visit:

<https://www.integra-biosciences.com/patents-trademarks>.

The VIAFLO 96/384 are covered under the following patents:

Patent Number	Country	Title	Apply to
8,033,188	USA	Pipettor Software Interface	VIAFLO 96/384
2192985	EPC/ FRAN/ GBRI/ SWIT	Pipettor Software Interface	VIAFLO 96/384
5221661	JAPA	Pipettor Software Interface	VIAFLO 96/384
602008010945	GERM	Pipettor Software Interface	VIAFLO 96/384
8,367,022	USA	Unintended Motion Control for Manually Directed, Multi-Channel Electronic Pipettor	VIAFLO 96/384
8,372,356	USA	Manually Directed, Multi-Channel Electronic Pipetting System	VIAFLO 96/384
8,468,900	USA	Pipette Tip Positioning for Manually-Directed Multi-Channel Electronic Pipettor	VIAFLO 96/384
7,811,522	USA	Sample Reservoir Kits With Disposable Liners	Reservoirs
D599,031	USA	A Liquid Sample Or Liquid Reagent Reservoir Kit	Reservoirs
8,277,757	USA	Pipette Tip Mounting Shaft	GRIPTIPS
8,501,118	USA	Disposable Pipette Tip	GRIPTIPS

7.4 Pipetting specifications

The specifications apply only to neat transfers when the instrument is used together with INTEGRA GRIPTIPS.

Head Part No.	Volume Range (µl)	Min. Scrolling Volume Increments (µl)	Test Volume (µl)	Accuracy (±%)	Precision (≤%)
6101 6131	0.5–12.5	0.01	1.25 6.25 12.5	8.0 2.0 1.5	3.0 1.5 1.0
6106 6136	(1 µl–)¹ 2–50	0.05	5 25 50	5.0 2.0 1.5	2.5 1.5 1.0
6102 6132	(2 µl–)¹ 5–125	0.1	12.5 62.5 125	3.0 2.0 1.5	1.7 1.5 1.0
6103 6123	(5 µl–)¹ 10–300 (– 310 µl)	0.5	30 150 300	2.5 1.5 1.2	1.5 1.0 0.8
6104 6124	(25 µl–)¹ 50–1250	1	125 625 1250	2.5 2.0 1.8	1.5 1.0 0.8

1. The volumes in brackets refer to extended volumes, see “Pipetting” under “3.4.4 Preferences” on page 18. For the extended range these specifications do not apply.

7.5 Pipetting speeds

Default pipetting speed (µl/s)					
	Pipetting head size				
Speed	12.5 µl	50 µl	125 µl	300 µl	1250 µl
1	0.53	2.6	4.9	11.8	47
2	1.13	5.7	10.7	25.4	102
3	2.81	14.2	26.5	63.2	253
4	3.60	18.1	33.8	80.7	324
5	4.38	22.1	41.2	98.3	394
6	5.75	29.0	54.1	129.1	518
7	8.28	41.7	77.9	185.9	745
8	10.50	53.0	98.9	235.8	945
9	11.81	59.6	111.2	265.3	1064
10	13.13	66.2	123.6	294.8	1182

The speeds apply to firmware version 2.91 or higher.

User defined pipetting speed (µl/s)					
	Pipetting head size				
Speed	12.5 µl	50 µl	125 µl	300 µl	1250 µl
Min. (µl/s)	0.07	0.4	0.7	1.6	6
Max. (µl/s)	14.01	70.5	131.8	314.4	1261

8 Accessories and consumables

8.1 Accessories

Pipetting heads	Volume range	Part no.
24 channel	10 – 300 µl	6123
	50 – 1250 µl	6124
96 channel	0.5 – 12.5 µl	6101
	2 – 50 µl	6106
	5 – 125 µl	6102
	10 – 300 µl	6103
	50 – 1250 µl	6104
384 channel	0.5 – 12.5 µl	6131
	2 – 50 µl	6136
	5 – 125 µl	6132



General	Part no.
Cooling block, PCR, 96 well	6250
Cooling block, PCR, 384 well	6255
MAG module, for magnetic separation	4900
HEATMAG module, for heating and magnetic separation	4901
COLDPLATE, for cooling and heating	4950
BIOSHAKE 3000, for shaking	4951
BIOSHAKE 3000-T, for heating and shaking	4952
O-ring removal tool for 300 µl and 1250 µl pipettes	161916





O-rings for tip fittings	Part no.
O-ring for 200/300 µl tip fittings, pack of 24	100-00027-50
O-ring for 200/300 µl tip fittings, pack of 100	125928
O-ring for 1000/1250 µl tip fittings, pack of 24	100-00028-50
O-ring for 1000/1250 µl tip fittings, pack of 100	125929

Plate holders	Part no.
Plate holder, standard (for 24 and 96 well plates)	6205
Plate holder, 384 well offset (for 24, 96 and 384 well plates)	6210
Plate holder, position A, spring loaded, 384 well offset (for 24, 96 and 384 well plates)	6215
Plate holder, position B, spring loaded, 384 well offset (for 24, 96 and 384 well plates)	6220
Plate holder for row dilution (for 24, 96 and 384 well plates)	6221
Plate holder for 24 channel pipetting head, 96 well offset (for 24 and 96 well plates). Required for tip loading and reformatting.	6222
Plate holder, position A, adjustable spring loaded, 384 well offset (for 24, 96 and 384 well plates)	6223
Plate holder, position B, adjustable spring loaded, 384 well offset (for 24, 96 and 384 well plates)	6224
Plate holder, position A, adjustable spring loaded, 1536 well offset (for 24, 96, 384 and 1536 well plates)	6225
Plate holder, position B, adjustable spring loaded, 1536 well offset (for 24, 96, 384 and 1536 well plates)	6226
Three position stage (occupies both positions A and B, for 96 and 384 well plates)	6230

8.2 Consumables

Automation friendly reservoirs 150 ml, disposable inserts		Part no.
	Base (standard footprint) for 150 ml automation friendly reservoir, non-sterile, pack of 8	6301
	Lid for 150 ml (and 300 ml) automation friendly reservoir, polypropylene, sterile, pack of 25	6302
Polystyrene	Trial pack, sterile (1 reservoir, 1 lid, 1 base)	6303
	Sterile, pack of 30 (30 individually wrapped, 1 trial pack)	6317
	Sterile, pack of 100 (4 sleeves, 1 base)	6318
Polypropylene	Trial pack, sterile (1 reservoir, 1 lid, 1 base)	6308
	Sterile, pack of 30 (30 individually wrapped, 1 trial pack)	6337
	Sterile, pack of 100 (4 sleeves, 1 trial pack)	6338

Automation friendly reservoirs 300 ml, disposable inserts		Part no.
	Base (standard footprint) for 300 ml automation friendly reservoir, non-sterile, pack of 8	6305
	Lid for 300 ml (and 150 ml) automation reservoir, polypropylene, sterile, pack of 25	6306
Polystyrene	Trial pack, sterile (1 reservoir, 1 lid, 1 base)	6307
	Sterile, pack of 30 (30 individually wrapped, 1 trial pack)	6327
	Sterile, pack of 100 (4 sleeves, 1 trial pack)	6328
Polypropylene	Trial pack, sterile (1 reservoir, 1 lid, 1 base)	6309
	Sterile, pack of 30 (30 individually wrapped, 1 trial pack)	6347
	Sterile, pack of 100 (4 sleeves, 1 trial pack)	6348
	12 column Polypropylene, sterile, pack of 30, individually wrapped	6363
	Polystyrene, sterile, pack of 30, individually wrapped	6364
	8 row Polypropylene, sterile, pack of 30, individually wrapped	6373
	Polystyrene, sterile, pack of 30, individually wrapped	6374

Deep well plates		Part no.
	300 ml, pyramid bottom, polypropylene, non-sterile, pack of 25	6351
	300 ml, pyramid bottom, polypropylene, sterile, pack of 25	6352
	96 V-shaped squares à 2.2 ml, polypropylene, sterile, pack of 50	6353
	252 ml, pyramid bottom, partitioned (21 ml / column), polypropylene, non-sterile, pack of 25	6361
	252 ml, pyramid bottom, partitioned (21 ml / column), polypropylene, pre-sterilized, pack of 25	6362
	252 ml, SUREFLO design, partitioned (21 ml / column), polystyrene, sterile, 30 individually wrapped	6363
	252 ml, SUREFLO design, partitioned (21 ml / column), polypropylene, sterile, 30 individually wrapped	6364
	256 ml, pyramid bottom, partitioned (32 ml / row), polypropylene, non-sterile, pack of 25	6371
	256 ml, pyramid bottom, partitioned (32 ml / row), polypropylene, pre-sterilized, pack of 25	6372
	256 ml, SUREFLO design, partitioned (32 ml / row), polystyrene, sterile, 30 individually wrapped	6373
	256 ml, SUREFLO design, partitioned (32 ml / row), polypropylene, sterile, 30 individually wrapped	6374

8.3 GRIPTIPS

INTEGRA offers a wide range of GRIPTIPS in the volume ranges from 12.5 µl – 5000 µl.



Visit the GRIPTIP Selector Guide (www.integra-biosciences.com/griptips) to find the correct GRIPTIPS and set a filter by available volumes, packaging and properties.

8.3.1 INTEGRA pipetting device

The GRIPTIPS selection depends on which pipette you work with.

- **GRIPTIPS for automation:** for MINI 96, VIAFLO 96, VIAFLO 384 and ASSIST PLUS. These GRIPTIPS have undergone straightness testing and were engineered to resist the shear forces of automated tip loading on benchtop pipetting systems. For 384 configuration GRIPTIPS, extra sturdy antistatic XYZ-racks are used.



NOTE

Autoclaving of GRIPTIPS for automation is not recommended as they may warp during the process, which can lead to incorrect tip loading and obstruct precise well targeting.

8.3.2 Package options

- **Automation friendly racks** (6xxx series): for automated tip loading, refillable with GREEN CHOICE inserts.
- **GREEN CHOICE** (64xx series): environmentally friendly refills allowing the reuse of existing racks and thus reduces plastic waste.

If recycling is available in your region, fill the outer carton in which your GRIPTIPS are delivered with the empty racks for pickup by a parcel service.

8.3.3 GRIPTIP properties

According to our cleanroom standards, all GRIPTIPS (non-sterile, pre-sterilized and sterile) comply with our VIAPURE claims. This states that all product are RNase, DNase, endotoxin and pyrogenic free.

- **Sterile/pre-sterilized** products are gamma irradiated within the minimum and maximum dosage range specified for INTEGRA sterile products. Racks are individually vacuum sealed in a bag and are considered sterile until opened. The entire case of 5 pre-sterilized GREEN CHOICE inserts is sealed.
- **Non-sterile** items are manufactured in the same cleanroom and packed in a carton case.
- **Long:** longer design allows easy access into deep laboratory vessels
- **Short:** shorter design allows easy access in 1536 well plates or improves ergonomics
- **Wide bore:** large opening at the tip end, reduces shear forces
- **Low retention:** low liquid retention, for liquids with low surface tension

Imprint

© 2024 INTEGRA Biosciences AG

All rights to this documentation are reserved. In particular the rights of reproduction, processing, translation and the form of presentation lie with INTEGRA Biosciences AG. Neither the complete documentation nor parts thereof may be reproduced in any way, or stored and processed using electronic media or distributed in any other way without the written consent of INTEGRA Biosciences AG.

Every effort has been made to provide complete and accurate information in this operating instruction manual. Although this manual should contain a specifically labeled warranty notice for the product, INTEGRA Biosciences AG makes no representations or warranties with respect to the contents of this manual and reserves the right to change this manual without notice if and when improvements are made.

INTEGRA Biosciences AG shall not be liable for any loss, damage, repair costs, incidental or consequential damages of any kind, whether based on express or implied warranty, contract, omission or strict liability, arising in connection with the design, development, installation or use of the products.

INTEGRA Biosciences AG aims to provide reliable and accurate data and documentation. If you find a discrepancy, we would be grateful for your assistance and ask you for email us at info@integra-biosciences.com.

This operating instruction manual has part number 125950, the version is V20. It applies to software version as of (see Toolbox - Device information):

Control unit (FW)	3.13 or higher
Instrument base (FW)	3.31 or higher

until a newer revision is released.

Manufacturer and customer service

Your local INTEGRA Biosciences representative, further information, and operating instructions in other languages can be found at www.integra-biosciences.com or are available on request info@integra-biosciences.com.

Manufacturer

INTEGRA Biosciences AG

Tardisstrasse 201
CH-7205 Zizers, **Switzerland**
T +41 81 286 95 30
info-ch@integra-biosciences.com

INTEGRA Biosciences Corp.

22 Friars Drive
Hudson, NH 03051, **USA**
T +1 603 578 5800
info-us@integra-biosciences.com

Direct sales country

Integra Biosciences PTY Ltd

Unit 55, 193-203 South Pine Road
Brendale QLD 4500, **Australia**
T +617 3497 5800
info-au@integra-biosciences.com

INTEGRA Biosciences (Shanghai) Co., Ltd.

Room 1110, No. 515 Huanke Road
Shanghai 201315, **China**
T +86 21 5844 7203
info-cn@integra-biosciences.com

INTEGRA Biosciences Nordic ApS

Vallensbækvej 22A 3TV
Brøndby 2605, **Denmark**
T +45 3173 5373
info-nordic@integra-biosciences.com

INTEGRA Biosciences SAS

8 avenue du Fief
95310 Saint Ouen l'Aumône, **France**
T +33 1 34 30 76 76
info-fr@integra-biosciences.com

INTEGRA Biosciences Deutschland GmbH

An der Amtmannsmühle 1
35444 Biebertal, **Germany**
T +49 6409 81 999 15
info-de@integra-biosciences.com

INTEGRA Biosciences KK

Higashikanda 1-5-6, Chiyoda-ku
Tokyo, 101-0031, **Japan**
T +813 5962 4936
info-jp@integra-biosciences.com

INTEGRA Biosciences Benelux BV

Smederijstraat 2
4814 DB Breda, **Netherlands**
T +31 630 609 866
info-benelux@integra-biosciences.com

INTEGRA Biosciences Ltd

2 Rivermead Business Park
Thatcham, Berks, RG19 4EP, **United Kingdom**
T +44 1635 797 00
info-uk@integra-biosciences.com

